



ALWAYS  
THE BEST  
**FLEXIBLE  
SAFETY  
BARRIERS**

---



NOVEMBER 2021



PRESENTS NEW MATERIALS



## CONTENTS

---

01	Rack Protection	page 08	09	Column Protection	page 64
02	Bollard	page 20	10	Door Frame Protections	page 72
03	Guard Rails	page 24	11	Loading Bay Protection	page 78
04	Cold Line	page 30	12	Wheel Stop	page 80
05	Pedestrian Safety Barriers	page 38	13	Cable Cover	page 84
06	Gates	page 44	14	Corner Protection	page 86
07	Link	page 50	15	Kerb	page 88
08	BFlex	page 58	16	Wall Protection	page 92

---

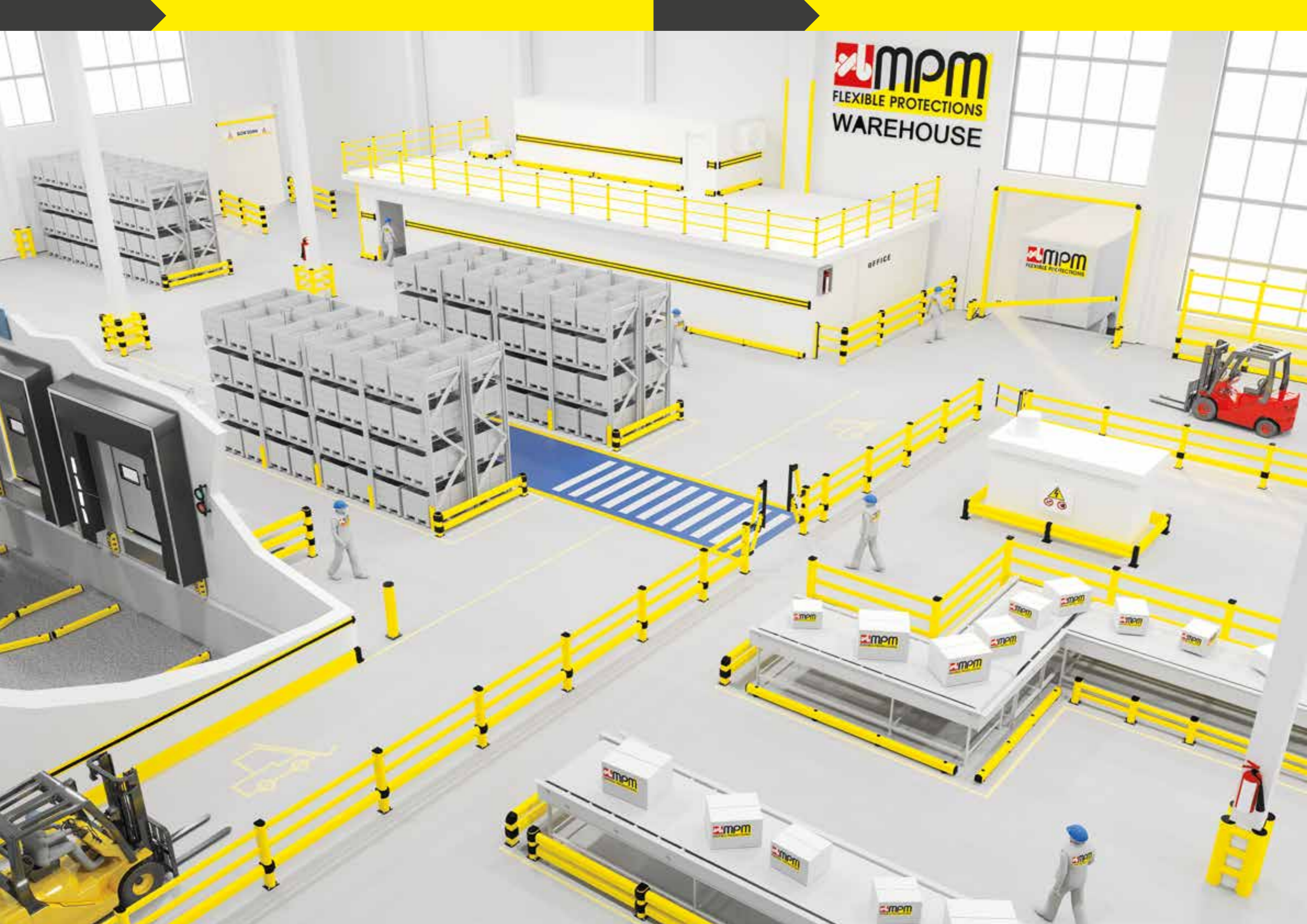

**mpm**  
FLEXIBLE PROTECTIONS  
WAREHOUSE

OFFICE

**mpm**  
FLEXIBLE PROTECTIONS

mpm

mpm

mpm

mpm

mpm

mpm

mpm

mpm

mpm

mpm

mpm

mpm

# OUR MATERIALS



RESEARCH AND DEVELOPMENT NEVER STOP!

# PIN SYSTEM

PED 150 PIN

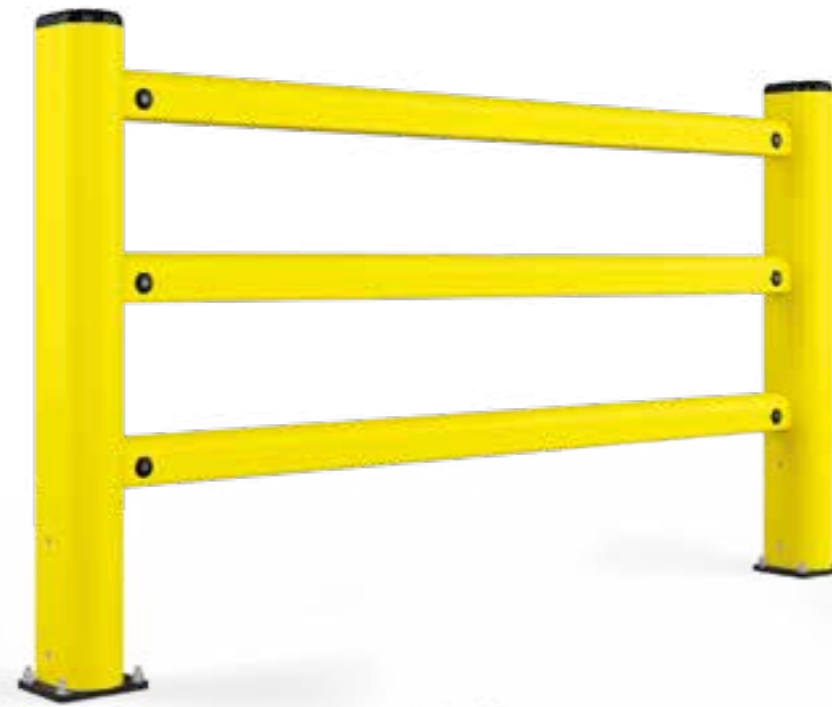

PED 200 PIN



**REFLEX**  
RESISTANT AND FLEXIBLE

**FROSTEX**  
RESISTANT TO LOW TEMPERATURES

RESISTANT OVER TIME	HIGH ELASTICITY	<b>RoHS compliant</b> COMPLIANT WITH THE DIRECTIVE UE 2015/863 (ROHS)
100% RECYCLABLE	SELF EXTINGUISHING V0	SCRATCHPROOF MATERIAL
HIGH VISIBILITY AND NO PAINTING REQUIRED	EASY TO CLEAN	ROT-PROOF AND NORMALLY MILDEW-PROOF MATERIAL
NO TOXIC	RESISTANT TO CHEMICALS OIL AND FUELS	RESISTANT TO HUMIDITY AND SALINITY

TEMPERATURE RANGE: -30° + 50° C	HIGH ELASTICITY	<b>RoHS compliant</b> COMPLIANT WITH THE DIRECTIVE UE 2015/863 (ROHS)
100% RECYCLABLE	HB FLAMMABILITY RATING ACCORDING TO UL 94	SUITABLE FOR FOOD CONTACT
HIGH VISIBILITY AND NO PAINTING REQUIRED	RESISTANT TO CHEMICALS OIL AND FUELS	ROT-PROOF AND NORMALLY MILDEW-PROOF MATERIAL
NO TOXIC	RESISTANT TO HUMIDITY AND SALINITY	

# NEWS

RESEARCH AND DEVELOPMENT NEVER STOP!

## ORANGE LINE

AVAILABLE FOR:  
LM / PED 150 /  
TOWER



HIGHER  
VISIBILITY  
FOR A GREATER  
SAFETY!

## CLIP 90



CUSTOMIZE  
YOUR BARRIER

EASY TO  
INSTALL

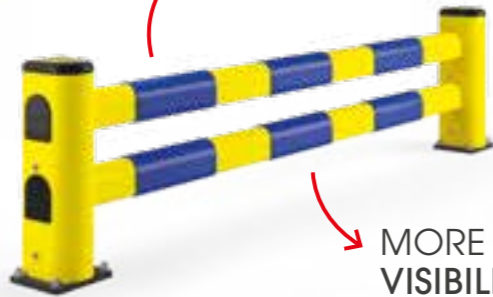

MORE  
VISIBILITY

## WORKSTATION

BIG SIZE  
UP TO 2500 x 940



DIFFERENT  
SIZES ON  
REQUEST

# GENIUS

THE LENGTH THAT YOU WISH



CUT THE RAIL AND DRILL IT  
WITH GENIUS



FOR MINI  
HUG TOWER

FOR HUG  
TOWER

FOR PEDESTRIAN  
BARRIER RAILS

FOR PEDESTRIAN  
BARRIER CORNER RAILS



WORLD'S UNIQUE SYSTEM!  
YOUR CUSTOMIZED BARRIER AND HUG TOWER

## SAFETY TOTEM

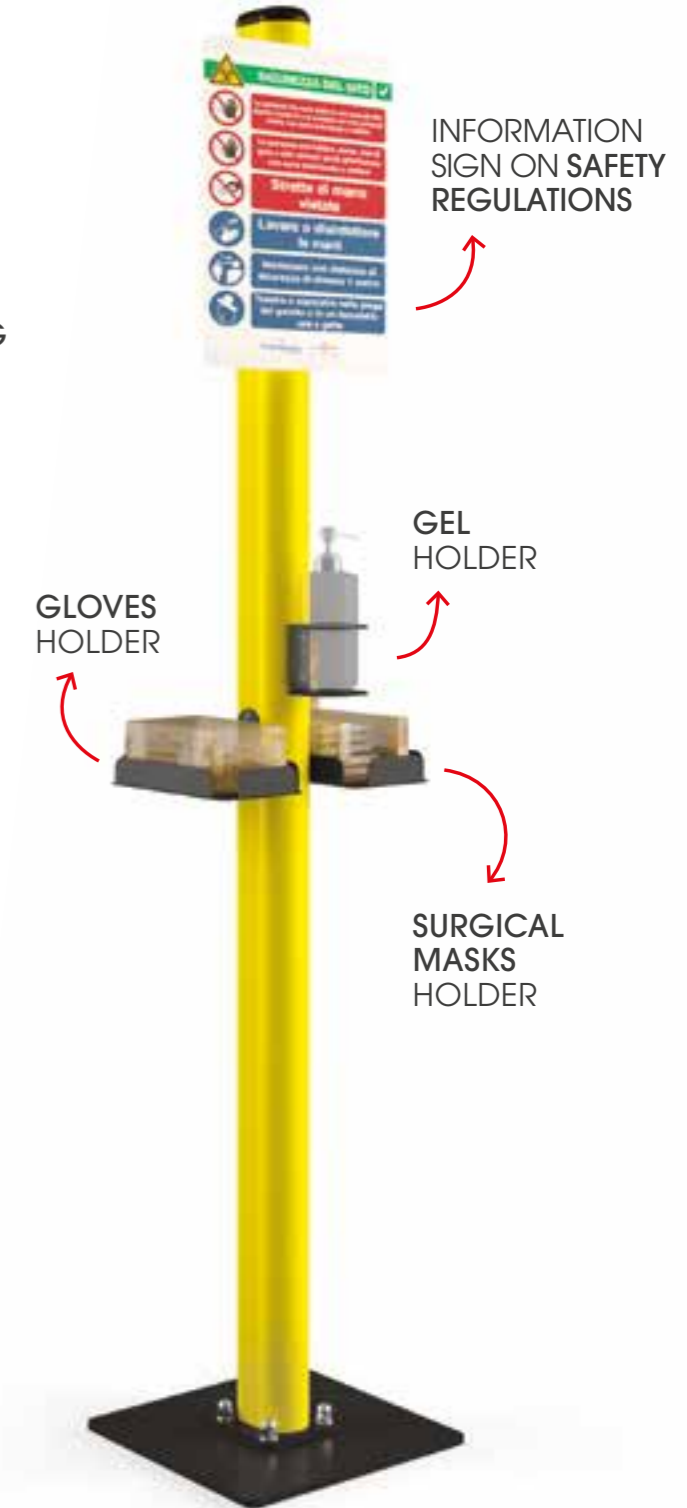

INFORMATION  
SIGN ON SAFETY  
REGULATIONS

GEL  
HOLDER

GLOVES  
HOLDER

SURGICAL  
MASKS  
HOLDER

# 01

## RACK PROTECTION OUR PROFILES FIT ALL RACKS

Full range of techno polymer profiles for protection of warehouse racks.

Gamma completa di profili in tecnopolimeri per la protezione di scaffali.

Complète gamme de profilés en tecnopolimère pour la protection d'étagères de dépôts.

Gama completa de perfiles de tecnopolímeros para las protecciones de estanterías.

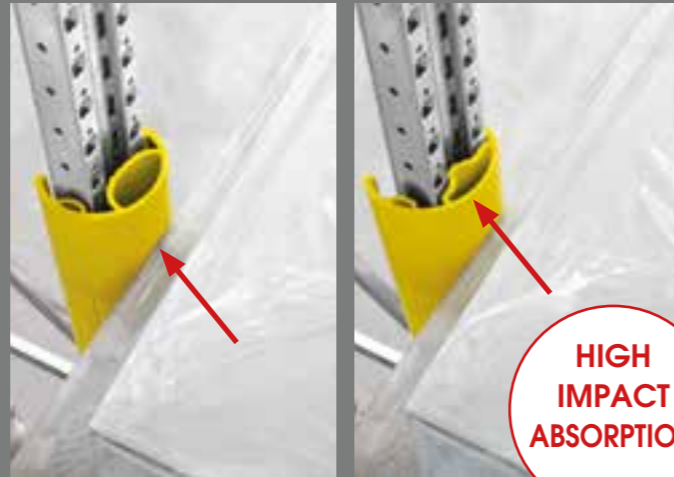

- ▶ **One big central shock absorber** in soft material to absorb front impacts.
- ▶ **Two side shock absorbers** in soft material to absorb impact during pallet placement on the rack.
- ▶ **Tested and certified** to EN 15512
- ▶ **Reduced dimensions** to keep manoeuvring spaces clear.
- ▶ **Interlocking system** with practical click-fit tools.
- ▶ **Rigid outer cladding, scratch-resistant** and easy to clean.



### RPS / RPM / RPL

EASY TO INSTALL

THE ONLY ONE WITH TRIPLE SHOCK ABSORBER



**RPS 600**

Small

Available also size 400



Packing 6 pz / box  
Packing 115 pz / big parcel  
Colour M



**RPM 600**

Medium

Available also size 400



Packing 4 pz / box  
Packing 80 pz / big parcel  
Colour M

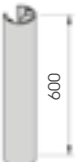

**RPL 600**

Large

Available also size 400



Packing 2 pz / box  
Packing 52 pz / big parcel  
Colour M

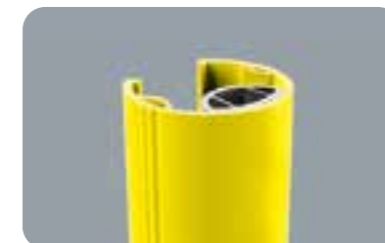
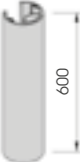

**RPL XL 600**

Extra Large

Available also size 400



Packing to be defined  
Colour M



**RP CLICK**

Packing 1 pz / box

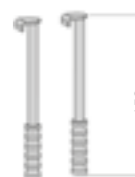

# RACK CORNER

ANTISHOCK MATERIAL INSIDE

FAST AND EASY TO INSTALL

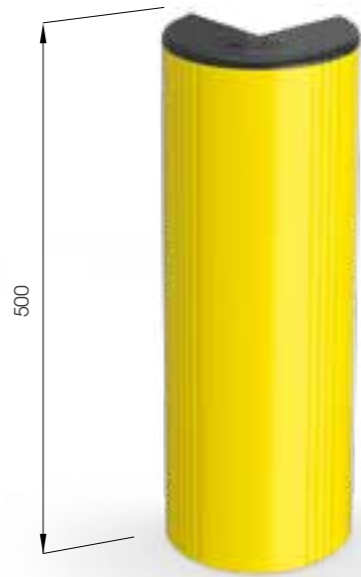

RACK CORNER

Equipped with accessories

Packing Colour **M** to be defined

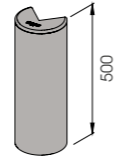

SM



DIFFERENT SIZES ON REQUEST

FAST AND EASY TO INSTALL



M12 GALVANISED STEEL



SM 1100x400

Equipped with accessories

Length 1.100  
Packing unpacked on pallet  
Colour **B** **M**

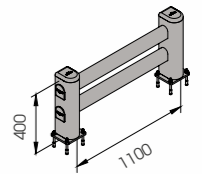

SM 1500x400 MODULAR

Equipped with accessories

Packing unpacked on pallet  
Colour **B** **M**

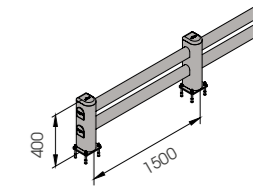

LM



DIFFERENT SIZES ON REQUEST

FAST AND EASY TO INSTALL



M12 GALVANISED STEEL



LM 1100x500  
2400x500

Length 1.100 / 2.400 mm  
Packing unpacked on pallet  
Colour B M

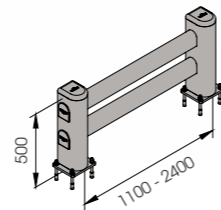

Equipped with accessories



LM 2000x500 MODULAR

Packing unpacked on pallet  
Colour B M

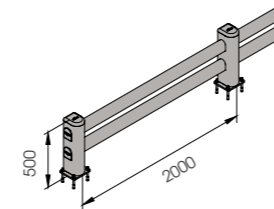

Equipped with accessories



NEW

LM/1 LINK



DIFFERENT SIZES ON REQUEST



M12 GALVANISED STEEL



LM/1 LINK 1100x500  
2400x500

Length 1.100 / 2.400 mm  
Packing unpacked on pallet  
Colour B M

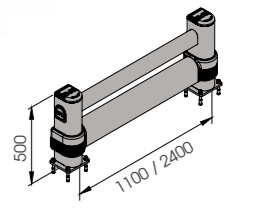

Equipped with accessories



LM / 1 LINK 2000x500  
MODULAR

Packing unpacked on pallet  
Colour B M

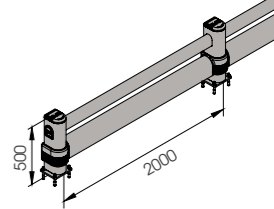

Equipped with accessories





# LINK SINGLE RE



DIFFERENT SIZES ON REQUEST



# LINK LM RE



DIFFERENT SIZES ON REQUEST



**LINK SINGLE RE** 1100x500  
1100x800  
2400x500  
2400x800

Length Packing 1.100 / 2.400 mm  
unpacked on pallet  
Colour B M

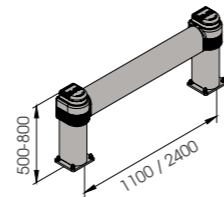

Equipped with accessories

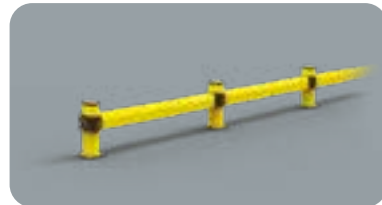

**LINK SINGLE 2000x500 MODULAR**  
**LINK SINGLE 2000x800 MODULAR**

Packing Colour unpacked on pallet  
B M

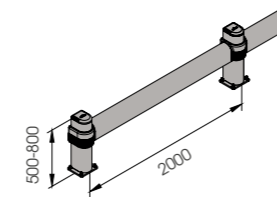

Equipped with accessories



**LINK LM RE** 1100x500  
1100x800  
2400x500  
2400x800

Length Packing 1.100 / 2.400 mm  
unpacked on pallet  
Colour B M

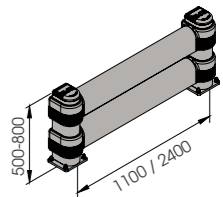

Equipped with accessories



**LINK LM 2000x500 MODULAR**  
**LINK LM 2000x800 MODULAR**

Packing Colour unpacked on pallet  
B M

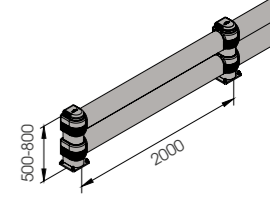

Equipped with accessories



# FENCE 90



DIFFERENT SIZES ON REQUEST

FAST AND EASY TO INSTALL



M12 GALVANISED STEEL



FE 90 1100x400

Length 1.100 mm  
Packing unpacked on pallet  
Colour B M



Equipped with accessories



FE 90 2400x400

Length 2.400 mm  
Packing unpacked on pallet  
Colour B M



Equipped with accessories



# FENCE 150



DIFFERENT SIZES ON REQUEST

FAST AND EASY TO INSTALL



M12 GALVANISED STEEL



FE 150 1100x550

Length 1.100 mm  
Packing unpacked on pallet  
Colour B M



Equipped with accessories



FE 150 2400x550

Length 2.400 mm  
Packing unpacked on pallet  
Colour B M



Equipped with accessories



# FENCE 150 REINFORCED



DIFFERENT SIZES ON REQUEST

FAST AND EASY TO INSTALL



FE 150 REF 1100x550

Length 1.100 mm  
Packing unpacked on pallet  
Colour B M



Equipped with accessories



FE 150 REF 2400x550

Length 2.400 mm  
Packing unpacked on pallet  
Colour B M



Equipped with accessories



# FENCE LINK



DIFFERENT SIZES ON REQUEST

FAST AND EASY TO INSTALL



FE LINK 1100x550

Length 1.100 mm  
Packing unpacked on pallet  
Colour B M

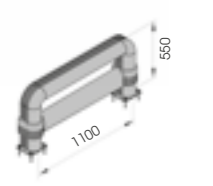

Equipped with accessories



FE LINK 2400x550

Length 2.400 mm  
Packing unpacked on pallet  
Colour B M

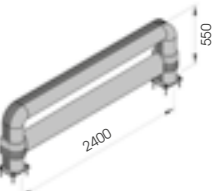

Equipped with accessories



# 02

## BOLLARD

Designed to protect access to gates or big doors from huge traffic or simply to mark restricted areas for pedestrians. Fully equipped with fixing accessories.

Ideato per proteggere l'accesso a cancelli o portoni dalla movimentazione di mezzi pesanti o semplicemente per impedire l'ingresso di pedoni. Provvisto di accessori di fissaggio.

Étudié pour protéger l'accès aux portes ou entrées de grand trafic ou simplement pour marquer les zones de passage piétons. Equipé avec les accessoires d'installation.

Diseñado para proteger el acceso a puertas o portones del movimiento de vehículos pesados o simplemente para evitar la entrada de peatones. Provisto de accesorios de fijación.



GRD 90



Bollard

FAST AND EASY TO INSTALL



M12 GALVANISED STEEL



GRD 90 250

Packing Colour **unpacked on pallet**  
 B  M

Equipped with accessories

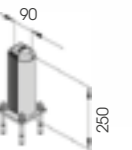

GRD 150

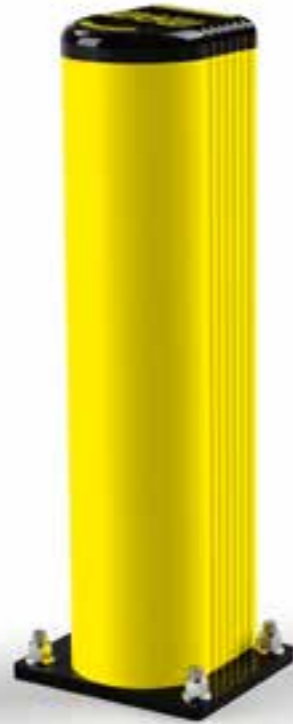

FAST AND EASY TO INSTALL



M12 GALVANISED STEEL

GRD 200

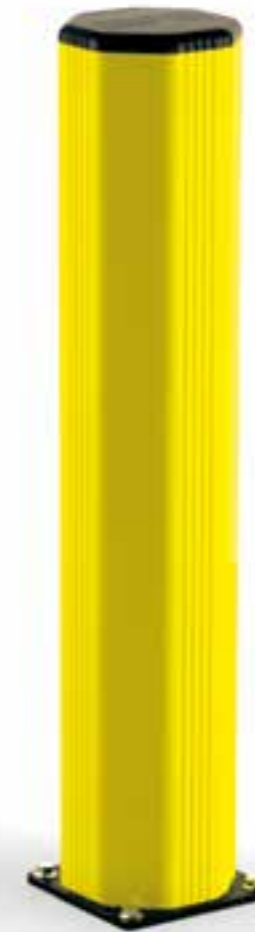

INCLUDED

FAST AND EASY TO INSTALL

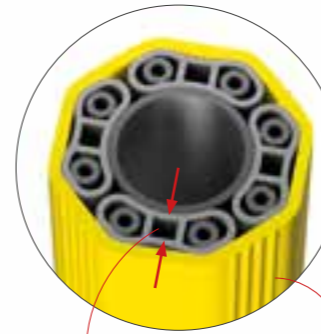

FLEXIBLE

NEW ANTISHOCK BUMPER



S16 GALVANISED STEEL



GRD 150 500  
800  
1150

Packing Colour **unpacked on pallet**  
B M

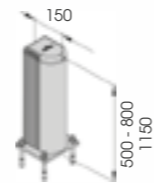

Equipped with accessories



GRD 200 1200  
2000

Packing Colour **unpacked on pallet**  
M

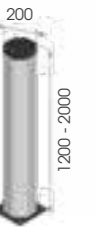

Equipped with accessories



## 03

GUARD  
RAILS

A new bumper system specific for the protection of the walls resistant against trolleys movements. Designed by following an innovative technical design that combines speed and simplicity in the steps of installation and cleaning. Available in different lengths.

Sistema profili antiurto specifico per la protezione delle pareti dai carrelli in movimento. Progettato seguendo un innovativo disegno tecnico che coniuga rapidità e semplicità nelle fasi di installazione e pulizia. Disponibile in diverse lunghezze.

Nouveau système bumper, spécifique pour protéger les murs contre les mouvements des charriots. Étudié avec un modern dessin qui regroupe la rapidité et la facilité pendant l'installation et le nettoyage. Disponible en différents longueurs.

Sistema de perfiles anti-impacto específico para la protección de las paredes de los carros en movimiento. Diseñado según un diseño técnico innovador que une velocidad y simplicidad en las fases de instalación y limpieza. Disponible en diferentes longitudes.

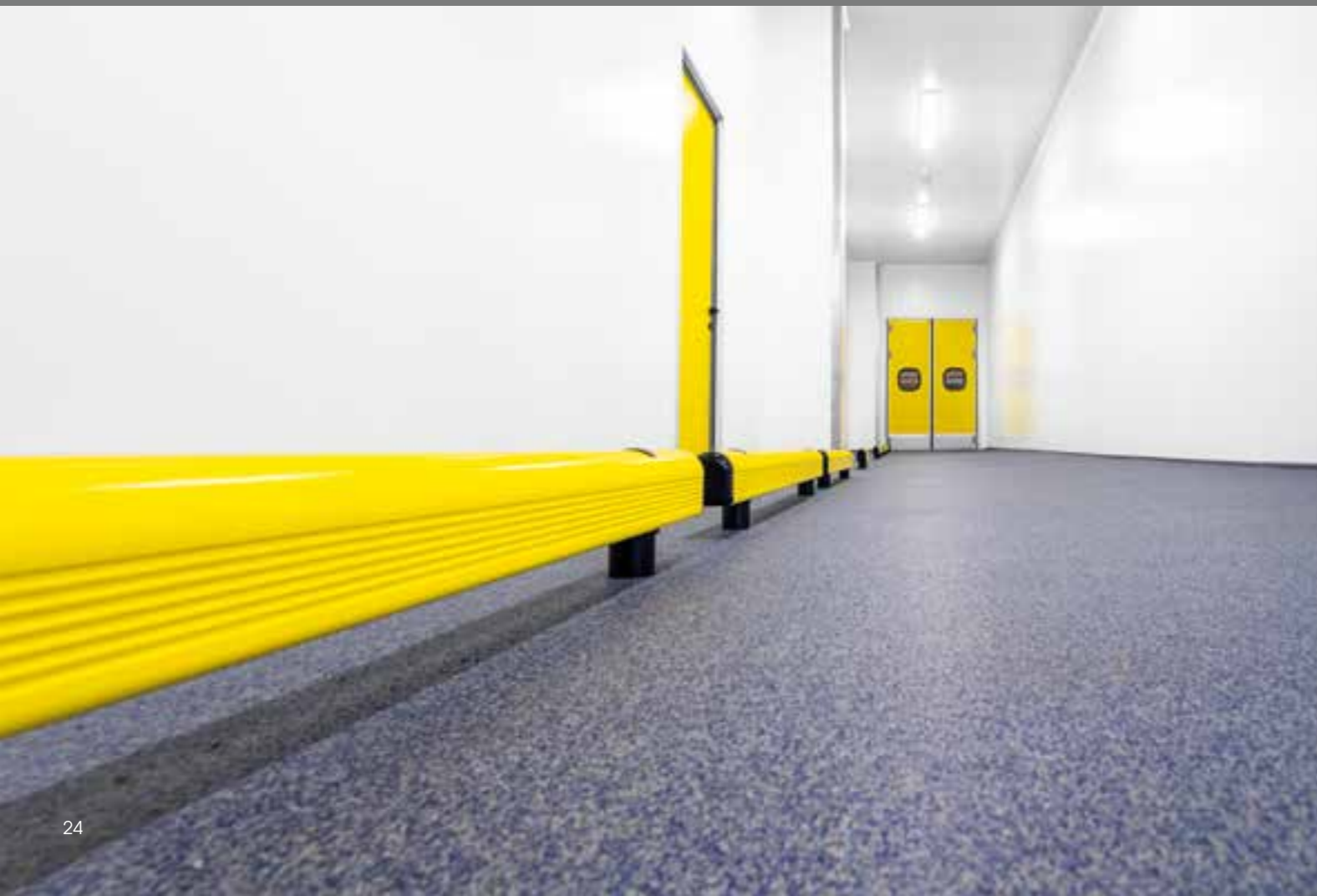

# GUARD RAIL 90



**QUICK INSTALLATION WITH EXPANSION SCREW**



**M16 GALVANISED STEEL**



**ALTERNATIVE FIXING**  
HIGH RESISTANCE WITH RESIN

**SF16 STAINLESS STEEL**



**GR 90** 500  
750  
1000  
1500

Length 500 mm  
Packing unpacked on pallet

Length 750 / 1000 / 1500 mm  
Packing 2 pz / box

Colour **B** **M**

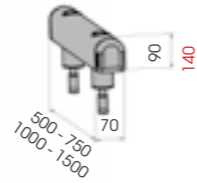

Equipped with accessories



**GR 90** 2000  
3000  
4000

Length 2.000 / 3.000 / 4.000 mm  
Packing unpacked on pallet

Colour **B** **M**

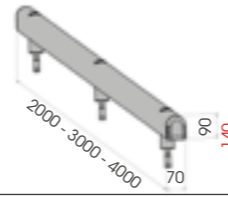

Equipped with accessories

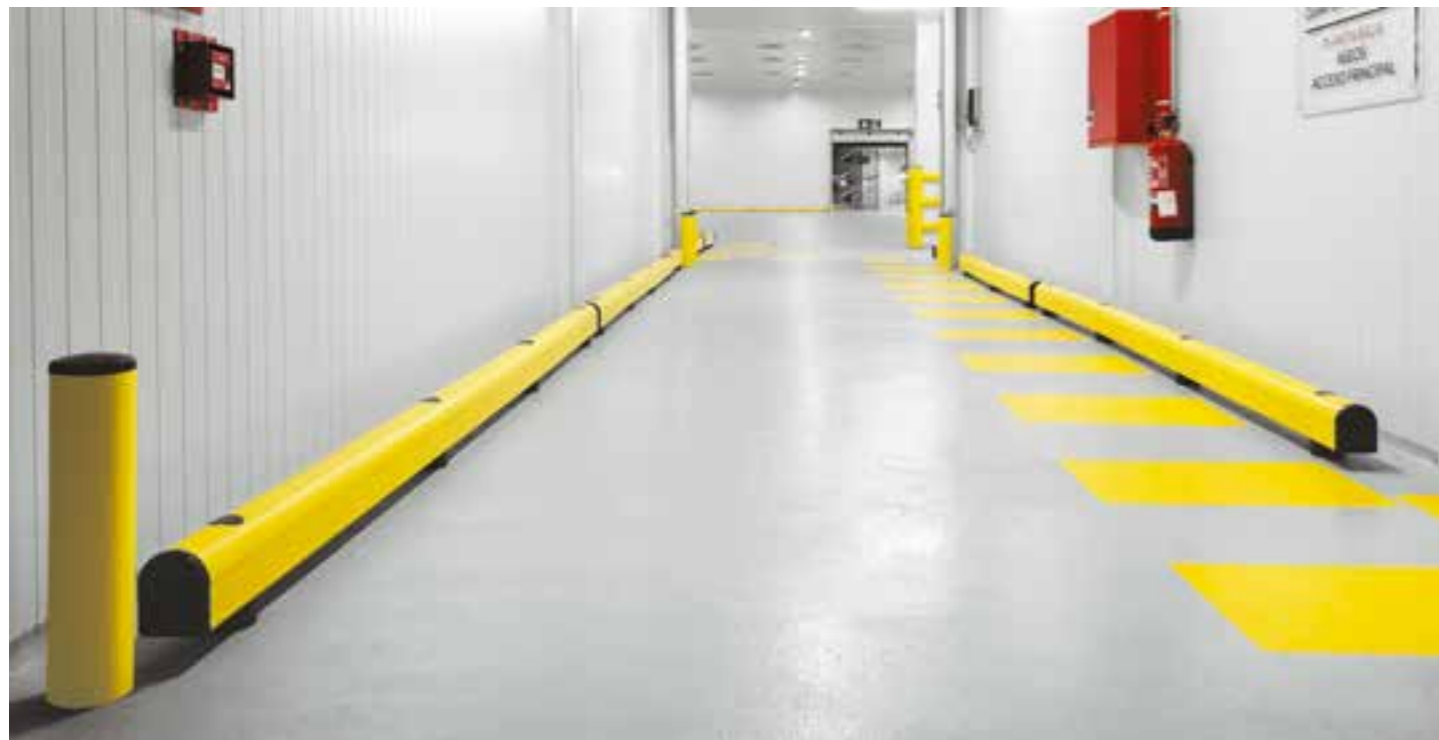

# GUARD RAIL 150



**HIGH RESISTANCE WITH RESIN**



**SF20 STAINLESS STEEL**



**GR 150** 500  
750  
1000  
1500

Length 500 / 750 / 1000 / 1500 mm  
Packing unpacked on pallet

Colour **B** **M**

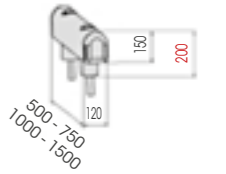

Equipped with accessories



**GR 150** 2000  
3000  
4000

Length 2.000 / 3.000 / 4.000 mm  
Packing unpacked on pallet

Colour **B** **M**

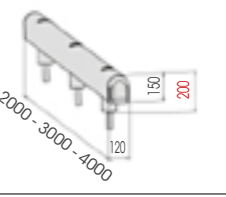

Equipped with accessories



# GRIN 90

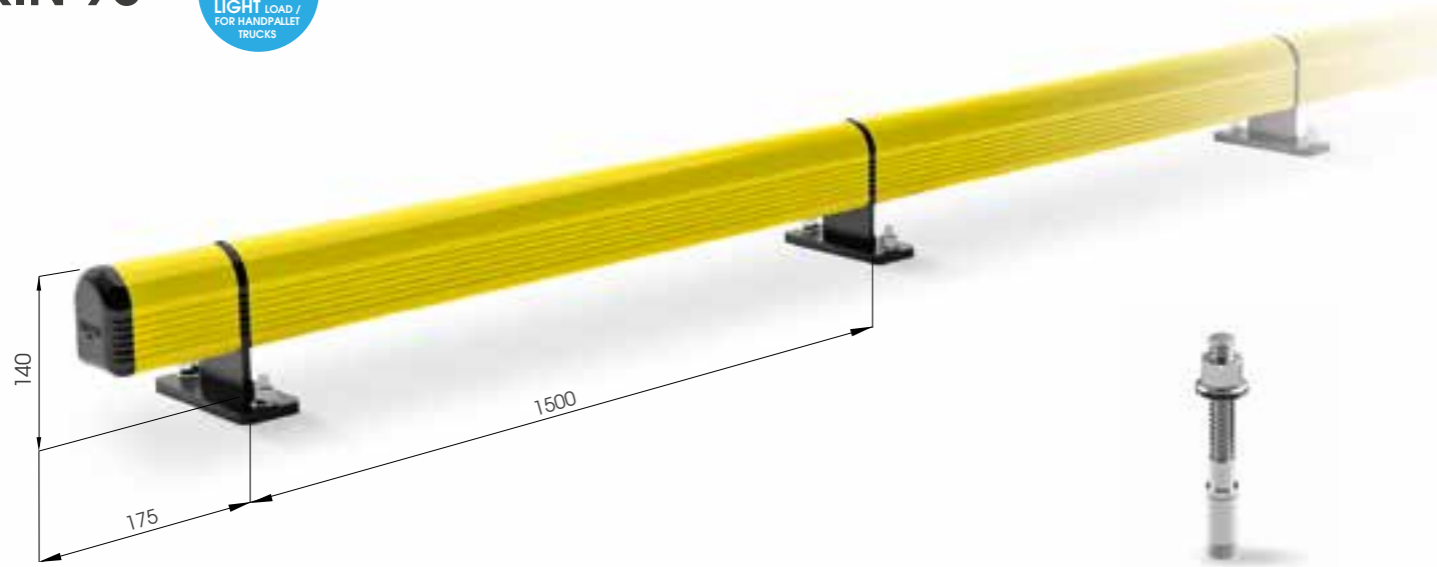

M12 GALVANISED STEEL

# GRIN 150



M12 GALVANISED STEEL



GRIN 90 1500

Length **1500 mm**  
Packing **to be defined**  
Colour **M**

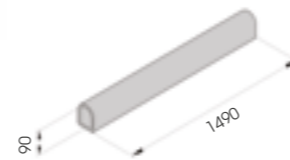

GRINCO 90

Packing **to be defined**  
Colour **M**



Equipped with accessories



GRINT 90

Packing **to be defined**  
Colour **M**



Equipped with accessories



GRIN 150 2000

Length **2000 mm**  
Packing **to be defined**  
Colour **M**

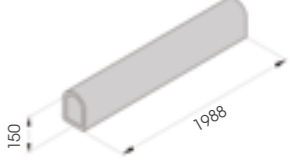

GRINCO 150

Packing **to be defined**  
Colour **M**



Equipped with accessories



GRINT 150

Packing **to be defined**  
Colour **M**



Equipped with accessories





# 04

## COLD LINE

Specific solutions for the protection of areas at risk of impact, in environments with negative temperature. They are suitable to protect corners, entrances, gates, panels and cold rooms walls.

Soluzioni specifiche per la protezione di zone a rischio d'impatto in ambienti a temperatura negativa. Ideali per proteggere angoli sporgenti, accessi e portoni, pannelli e pareti di celle frigorifere.

Solutions spécifiques pour la protection des zones à risque de collision dans les environnements à température négative. Idéal pour protéger les angles, les entrées et les portes, les panneaux et les murs des chambres froides.

Soluciones específicas para proteger las zonas con riesgo de impacto en entornos de temperatura negativa. Son ideales para proteger esquinas, entradas y puertas, paneles y paredes de las cámaras frigoríficas.



RESISTANT TO LOW TEMPERATURES



**ROD 70**



**REMOVABLE**  
EASY TO REMOVE AND TO REPLACE



**M20 GALVANISED STEEL**



**ROD 120**



**REMOVABLE**  
EASY TO REMOVE AND TO REPLACE



**M30 GALVANISED STEEL**



**Fixing accessory available also in stainless steel**



**ROD 70 266**

Packing Colour **M**  
1 pz / box

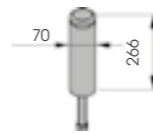

**Drill Ø 38**  
Equipped with accessories

**Fixing accessory available also in stainless steel**



**ROD 120 433  
560  
800**

Packing Colour **M**  
1 pz / bag

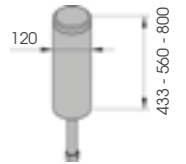

**Drill Ø 56**  
Equipped with accessories



# ROD FLOOR 70



**QUICK  
INSTALLATION  
WITH  
EXPANSION  
SCREW**



**M16  
GALVANISED STEEL**

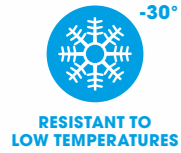

**RF 70** 500  
1000  
1500

Length 500 / 1000 / 1500 mm  
Packing unpacked on pallet  
Colour **M**

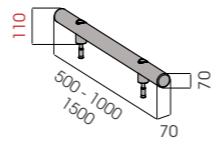

Equipped with accessories



**RF 70** 2000  
3000

Length 2.000 / 3.000 mm  
Packing unpacked on pallet  
Colour **M**

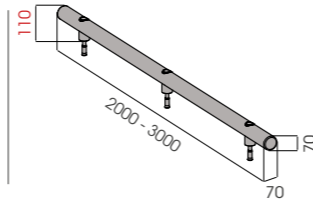

Equipped with accessories



# ROD FLOOR 120



**HIGH  
RESISTANCE  
WITH  
RESIN**



**SF20  
STAINLESS STEEL**

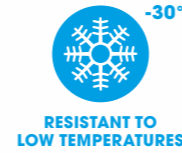

**RF 120** 500  
1000  
1100  
1500

Length 500 / 1000 / 1100 / 1500 mm  
Packing unpacked on pallet  
Colour **M**

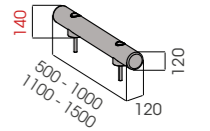

Equipped with accessories



**RF 120** 2000  
2500  
3000

Length 2.000 / 2.100 / 3.000 mm  
Packing unpacked on pallet  
Colour **M**

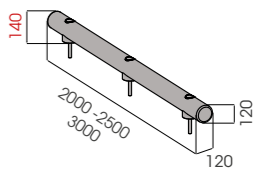

Equipped with accessories



# ROD FLOOR 120 DOUBLE RE



SF20 x 450  
STAINLESS STEEL



350

NOT SHARP EDGES



RESISTANT TO  
LOW TEMPERATURES



## RF 120 DOUBLE 1100

Length 1100 mm  
Packing unpacked on pallet  
Colour M

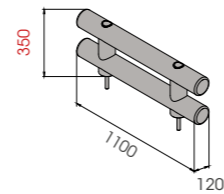

Equipped with accessories



## RF 120 DOUBLE 2500

Length 2.500 mm  
Packing unpacked on pallet  
Colour M

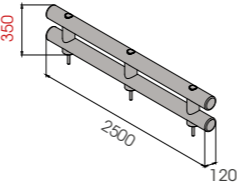

Equipped with accessories



# ROD FLOOR 120 DOUBLE



SF20 x 450  
STAINLESS STEEL

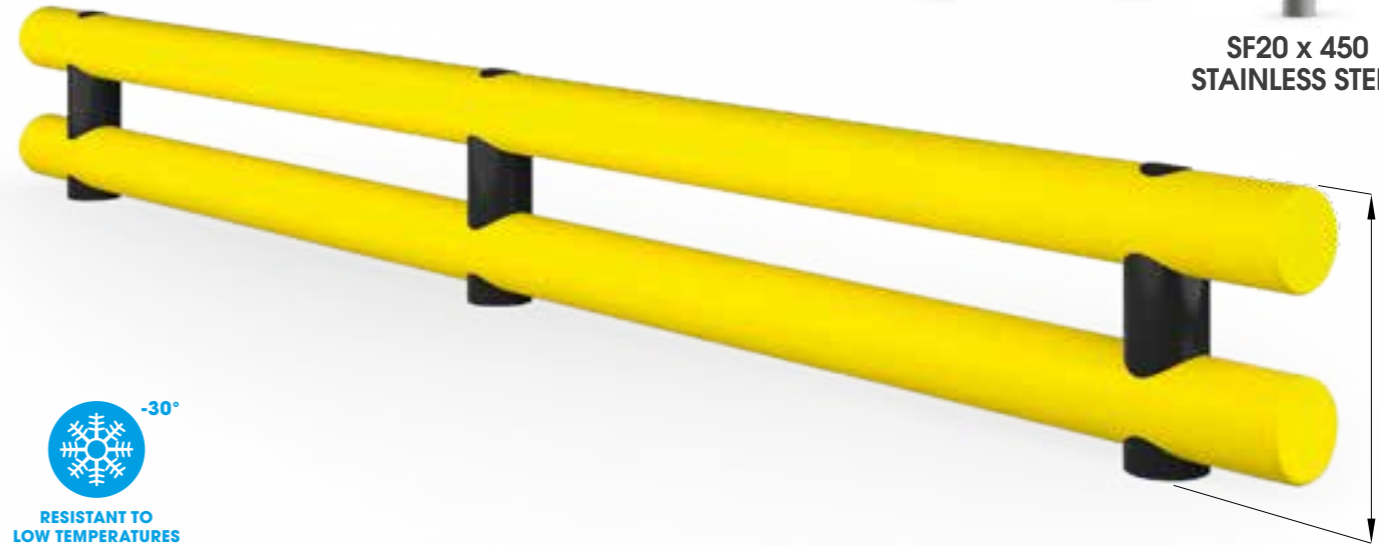

350



RESISTANT TO  
LOW TEMPERATURES



## RF 120 DOUBLE 500 1000 1500

Length 500 / 1000 / 1500 mm  
Packing unpacked on pallet  
Colour M

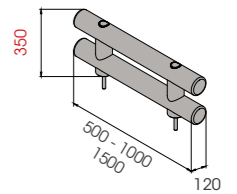

Equipped with accessories

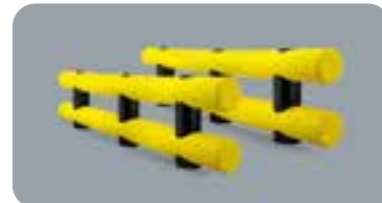

## RF 120 DOUBLE 2000 3000

Length 2.000 / 3.000 mm  
Packing unpacked on pallet  
Colour M

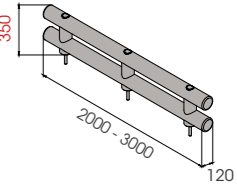

Equipped with accessories



# 05

## PEDESTRIAN SAFETY BARRIERS

A new protection system specific for the protection of pedestrians and resistant to trolleys movements with different load types. Designed by following an innovative technical design that combines speed and simplicity in the steps of installation and cleaning. Available in different lengths.

Sistema di profili antiurto specifico per la protezione delle aree pedonali dai carrelli in movimento con diverse portate di carico. Progettato seguendo un innovativo disegno tecnico che coniuga rapidità e semplicità nelle fasi di installazione e pulizia. Disponibile in diverse lunghezze.

Nouveau système bumper, spécifique pour protéger les zones piétonnes contre les mouvements des charriots. Étudié avec un modern dessin qui regroupe la rapidité et la facilité pendant l'installation et le nettoyage. Disponible en différents longueurs.

Sistema específico de perfiles antichoque para la protección de zonas peatonales de carros en movimiento con diferentes capacidades de carga. Diseñado según un diseño técnico innovador que une velocidad y simplicidad en las fases de instalación y limpieza. Disponible en diferentes longitudes.



### HAND RAIL 90



FAST AND EASY TO INSTALL

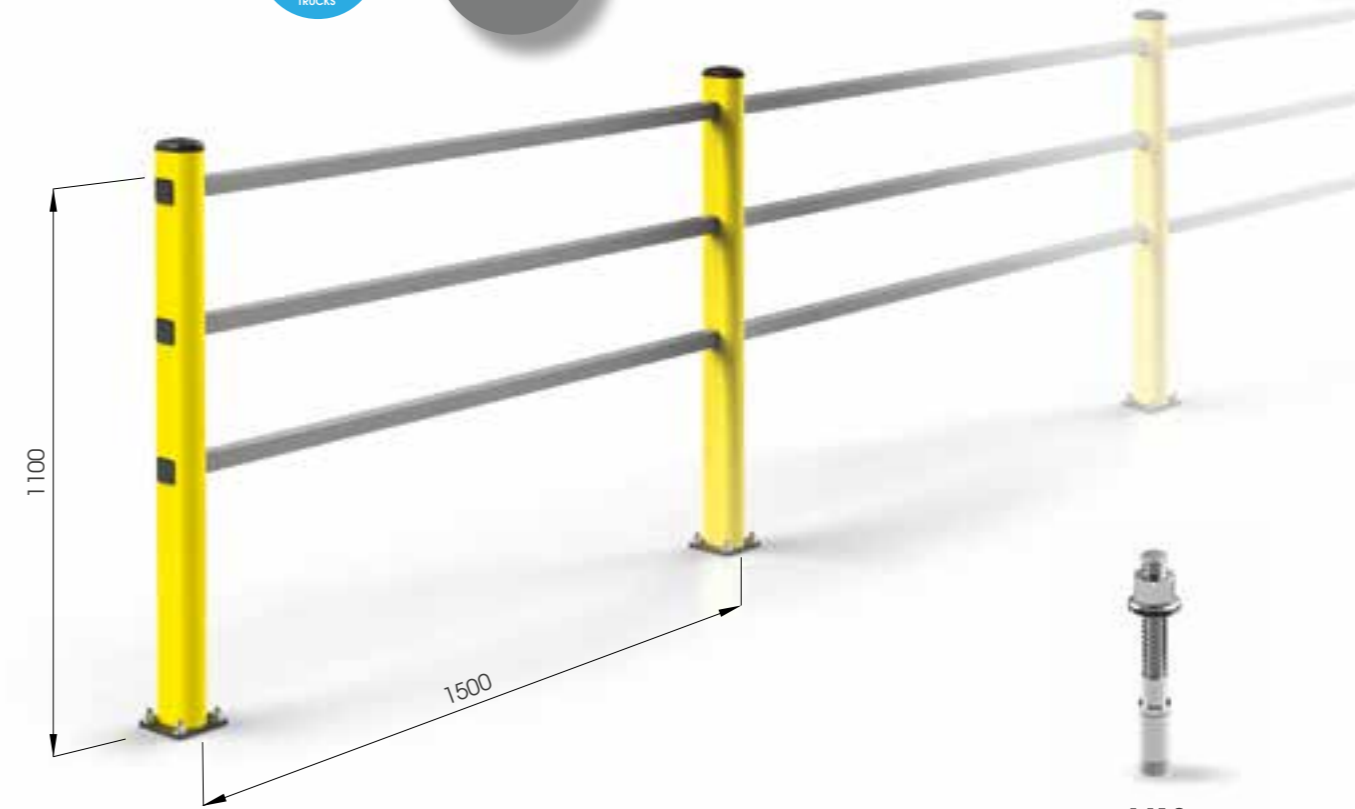

M12 GALVANISED STEEL

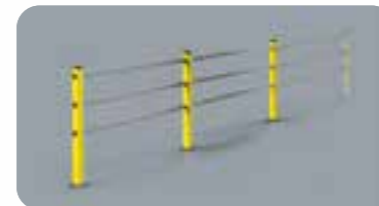

HR 90 1500x1150 MODULAR

Packing Colour **unpacked on pallet** M

Equipped with accessories

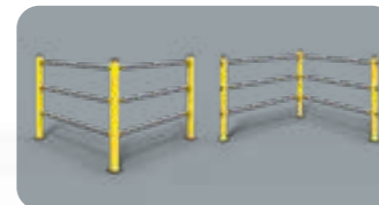

HR 90 1500x1150 CORNER

Packing Colour **unpacked on pallet** M

Equipped with accessories

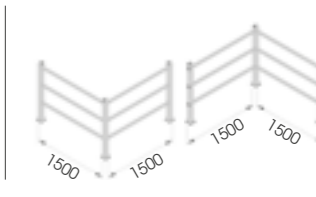

# PEDESTRIAN 90



FAST AND EASY TO INSTALL



M12 GALVANISED STEEL



PED 90 1500x1150 MODULAR

Packing Colour **unpacked on pallet**  
 B  M



Equipped with accessories

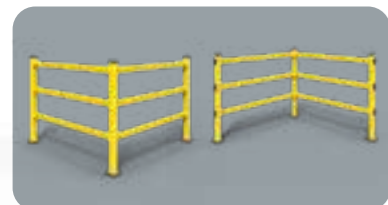

PED 90 1500x1150 CORNER

Packing Colour **unpacked on pallet**  
 B  M

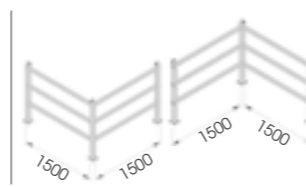

Equipped with accessories



# PEDESTRIAN 150



FAST AND EASY TO INSTALL



M12 GALVANISED STEEL



PED 150 2000x1150 MODULAR

Packing Colour **unpacked on pallet**  
 B  M

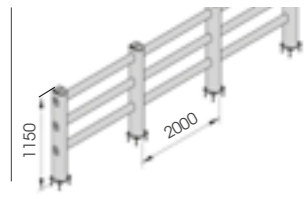

Equipped with accessories



PED 150 2000x1150 CORNER

Packing Colour **unpacked on pallet**  
 B  M



Equipped with accessories



# PEDESTRIAN 90 REINFORCED



**PED 90 REF MODULAR**

Packing Colour **B** **M** unpacked on pallet

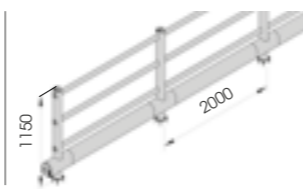

Equipped with accessories



# PEDESTRIAN 150 LINK



**PED 150 LINK**

External Corners available

Packing Colour **B** **M** unpacked on pallet



Equipped with accessories



## 06

## GATES

Safety gate system with different opening possibilities, ideated to be installed on our pedestrian barriers. Designed by following an innovative technical design that combines speed and simplicity in the steps of installation and cleaning. Available in different opening systems.

Sistema di cancelli antiurto ideati per l'installazione nelle nostre barriere di protezione per aree pedonali. Progettati seguendo un innovativo disegno tecnico che coniuga rapidità e semplicità nelle fasi di installazione e pulizia. Disponibili molteplici sistemi di apertura.

Système de portillons résistant aux chocs étudié pour l'installation de nos barrières de protections pour les zones piétons. Portillons conçus suivant un design innovant qui combine rapidité et simplicité pendant le montage et le nettoyage. Différents systèmes d'ouvertures disponibles.

Sistema de puertas antigolpe diseñadas para la instalación de nuestras barreras de protección para áreas peatonales. Diseñado según un diseño técnico innovador que une velocidad y simplicidad en las fases de instalación y limpieza. Están disponibles varios sistemas de apertura.





# DOOR PEDESTRIAN 90

DIFFERENT SIZES ON REQUEST



DP 90 ONE WAY

Packing Colour **to be defined**  
M P

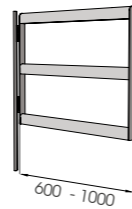

Equipped with accessories



DP 90 SWING

Packing Colour **to be defined**  
M P

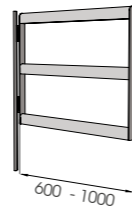

Equipped with accessories

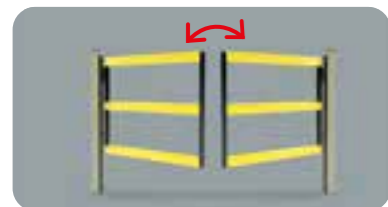

DP 90 SWING DOUBLE

Packing Colour **to be defined**  
M P

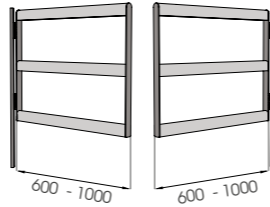

Equipped with accessories



# DOOR PEDESTRIAN 150

DIFFERENT SIZES ON REQUEST

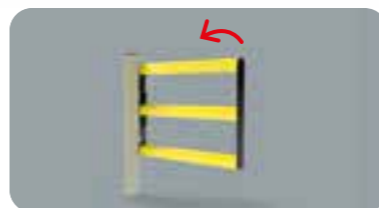

DP 150 ONE WAY

Packing Colour **to be defined**  
M P

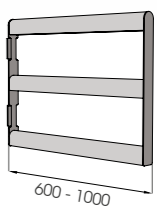

Equipped with accessories

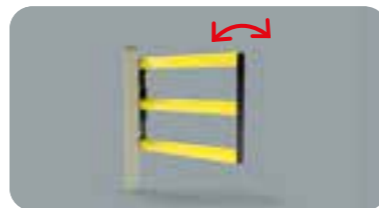

DP 150 SWING

Packing Colour **to be defined**  
M P

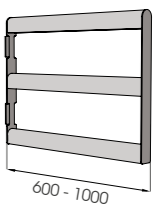

Equipped with accessories

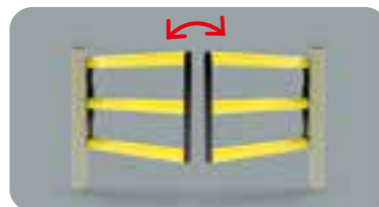

DP 150 SWING DOUBLE

Packing Colour **to be defined**  
M P

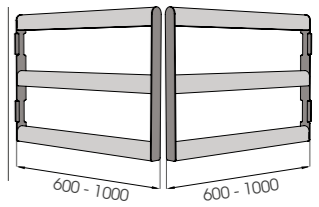

Equipped with accessories



# LIFT GATE 90

DIFFERENT SIZES ON REQUEST

NEW

# LIFT GATE 90 DOUBLE



DOUBLE GATE

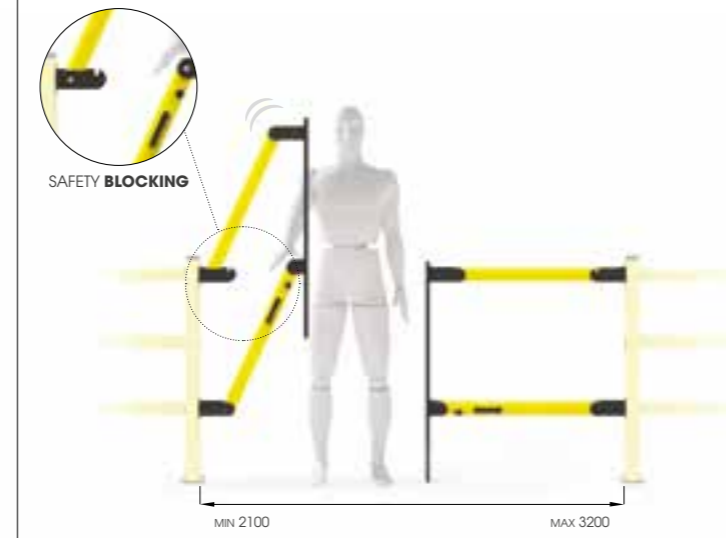
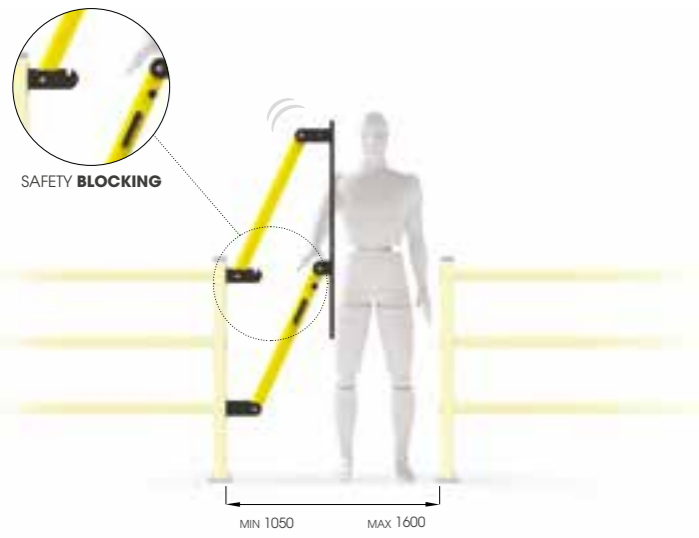

LIFT GATE 90

Equipped with accessories

Packing Colour **to be defined**  
M P



1050 - 1600



LIFT GATE 90 DOUBLE

Equipped with accessories

Packing Colour **to be defined**  
M P

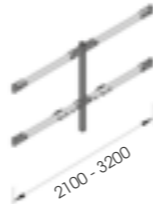

2100 - 3200



# LIFT GATE 150

DIFFERENT SIZES ON REQUEST

NEW

# LIFT GATE 150 DOUBLE

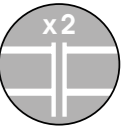

DOUBLE GATE

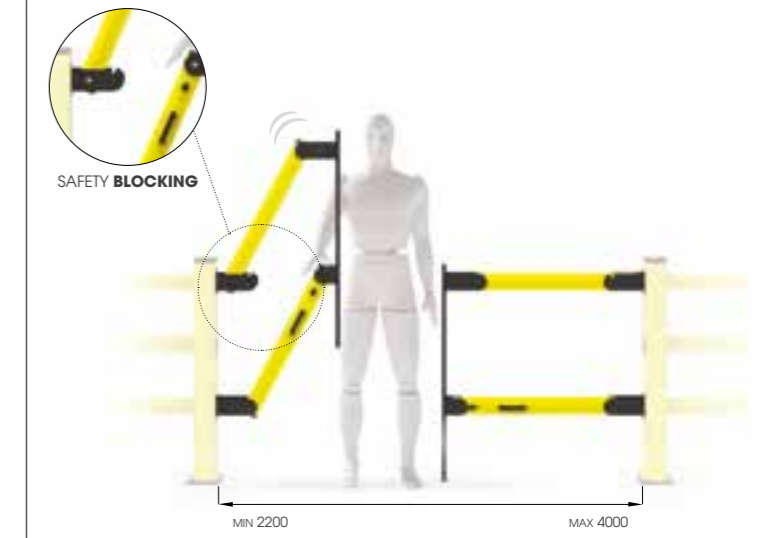
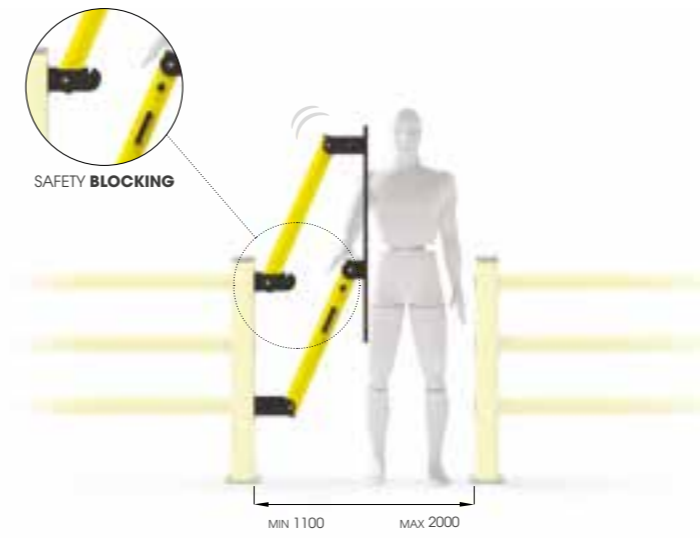

LIFT GATE 150

Equipped with accessories

Packing Colour **to be defined**  
M P



1100 - 2000



LIFT GATE 150 DOUBLE

Equipped with accessories

Packing Colour **to be defined**  
M P

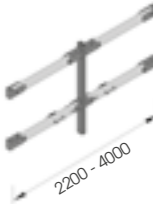

2200 - 4000



# 07

## LINK

The first adaptable barrier in the world thanks to the new connection system. Rail adjustable height, easy to set up, higher resistance in the most critical points.

Prima barriera al mondo regolabile a piacimento con nuovo sistema di raccordo. Altezza regolabile, facilmente componibili e resistenza potenziata nei punti piu' critici.

Première barrière au monde à modifier aux besoins avec un nouveau système de jonction. Hauteur à changer, facile à assembler et résistance renforcée aux points plus compliqués.

Primera barrera del mundo ajustable según lo necesario con un nuevo sistema de ajuste. Altura ajustable, fácilmente componibles y resistencia potenciada en los puntos más críticos.

**NEW  
PRODUCT**



**ADAPTABLE  
HEIGHT**  
↕  
**ON YOUR  
NEEDS**

### LINK 150/3



Link

**DIFFERENT  
SIZES ON  
REQUEST**



**M12  
GALVANISED STEEL**



#### LINK 150/3

Packing **unpacked on pallet**  
Colour **B M**

Equipped with accessories

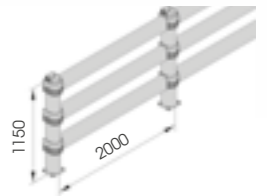

#### LINK 150/3 CORNER

Packing **unpacked on pallet**  
Colour **B M**

**External Corners  
available**

Equipped with accessories

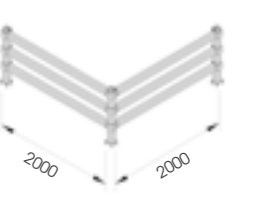

# LINK 150/2

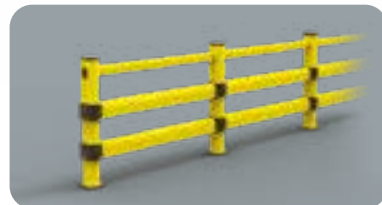

LINK 150/2

Equipped with accessories

Packing Colour **B** **M** unpacked on pallet



LINK 150/2 CORNER

External Corners available

Equipped with accessories

Packing Colour **B** **M** unpacked on pallet

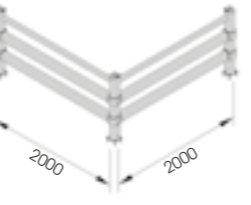

# LINK 150/1



LINK 150/1

Equipped with accessories

Packing Colour **B** **M** unpacked on pallet

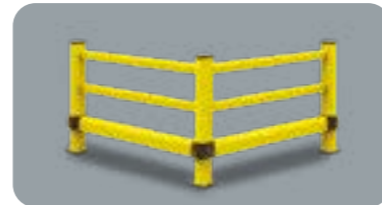
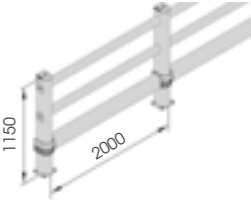

LINK 150/1 CORNER

External Corners available

Equipped with accessories

Packing Colour **B** **M** unpacked on pallet

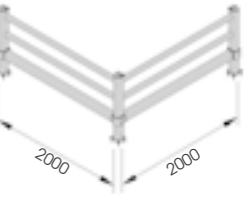

# LINK LM



DIFFERENT SIZES ON REQUEST



# LINK SINGLE



DIFFERENT SIZES ON REQUEST

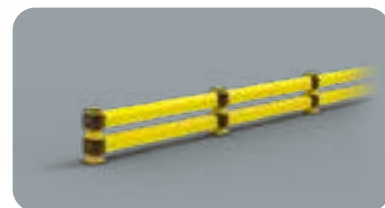

**LINK LM 500  
800**

Equipped with accessories

Packing Colour **unpacked on pallet**  
B M

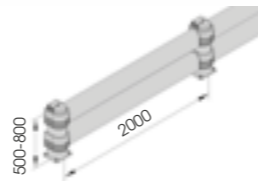

**LINK SINGLE 500  
800**

Equipped with accessories

Packing Colour **unpacked on pallet**  
B M

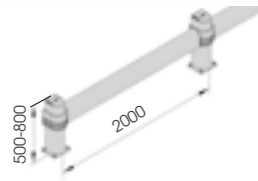

**LINK LM  
CORNER**

**External Corners  
available**

Equipped with accessories

Packing Colour **unpacked on pallet**  
B M

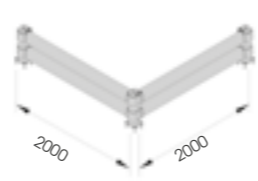

**LINK SINGLE  
CORNER**

**External Corners  
available**

Equipped with accessories

Packing Colour **unpacked on pallet**  
B M



NOW READY  
**NEW OPTIONS FOR**  
OUR **SAFETY BARRIERS**  
AND **RACK PROTECTORS**



AVAILABLE FOR:  
**LINK / SM / LM / FENCE**  
**HR 90 / PED 90 / PED 150**



# 08

## B FLEX

A new safety protection system with reinforced profile. It is a more flexible and shock-absorber solution. Designed to ensure high safety standards and to resist impacts from heavy loads. Available in many different versions.

Nuovo sistema di protezioni con profilo rinforzato, doppiamente flessibile e assorbente. Progettato e realizzato con un particolare design per garantire alti livelli di sicurezza e resistere all'impatto da carichi pesanti. Disponibile in diverse versioni.

Nouveau système de protection avec profil renforcé, doublement flexible et absorbant. Conçu et produit avec un design particulier pour assurer des niveaux élevés de sécurité et résister à l'impact des charges lourdes. Disponible en plusieurs versions.

Nuevo sistema de protección con perfil reforzado, más flexible y capaz de absorber los impactos. Diseñado para asegurar el entorno laboral y para resistir a los impactos de cargas pesadas. Disponible en diferentes versiones.

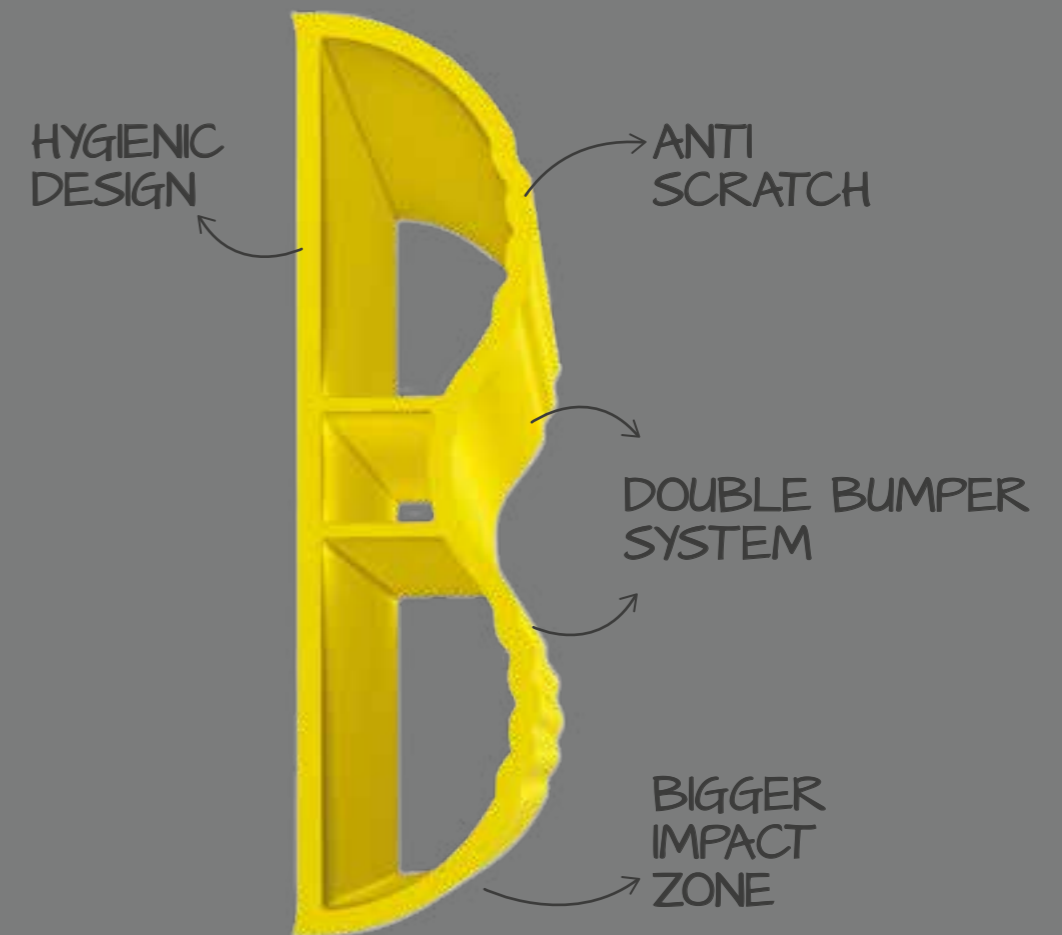

# BFLEX.FRONT/1



**BFLEX.FRONT/1 1100x450**  
**BFLEX.FRONT/1 2400x450**

Length 1.100 / 2.400 mm  
Packing unpacked on pallet  
Colour **M**

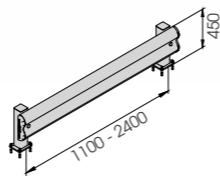

Equipped with accessories



**BFLEX.FRONT/1 2000x450 MODULAR**

Packing unpacked on pallet  
Colour **M**

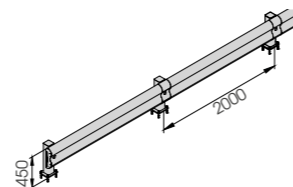

Equipped with accessories



# BFLEX.FRONT/2



**BFLEX.FRONT/2 1100x1100**  
**BFLEX.FRONT/2 2400x1100**

Length 1.100 / 2.400 mm  
Packing unpacked on pallet  
Colour **M**

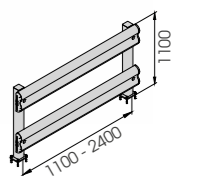

Equipped with accessories



**BFLEX.FRONT/2 2000x1100 MODULAR**

Packing unpacked on pallet  
Colour **M**

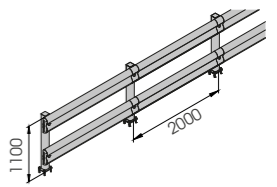

Equipped with accessories





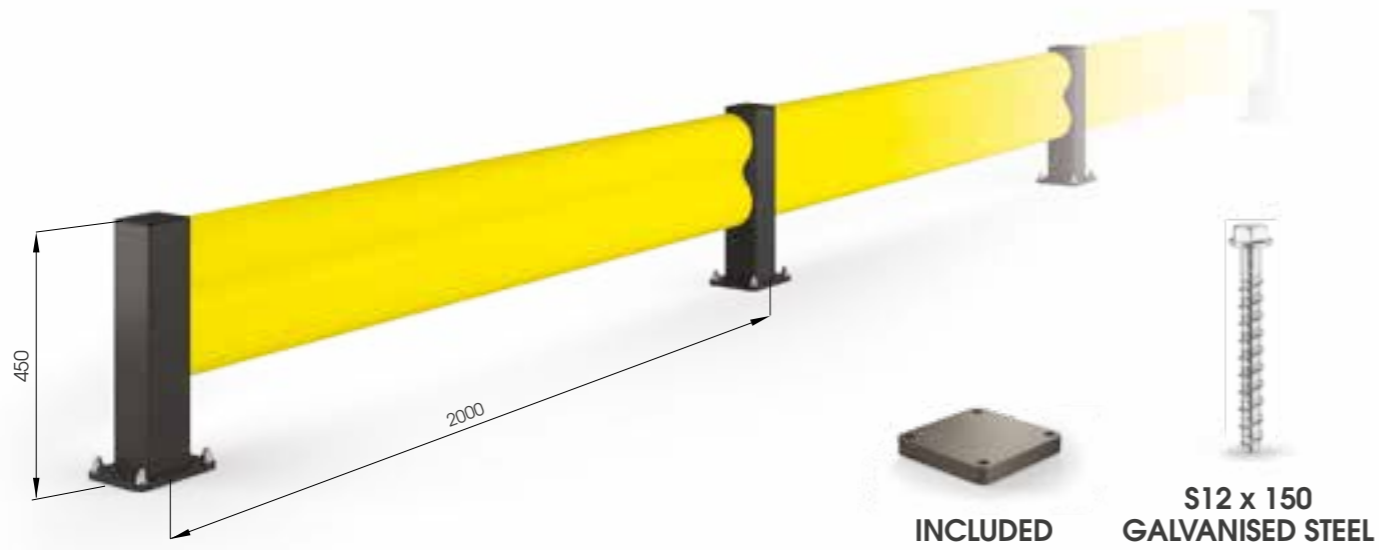

INCLUDED

S12 x 150  
GALVANISED STEEL



BFLEX.COM/1 1100x450  
BFLEX.COM/1 2400x450

Length 1.100 / 2.400 mm  
Packing unpacked on pallet  
Colour M

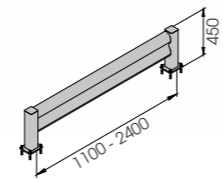

Equipped with accessories



BFLEX.COM/1 2000x450  
MODULAR

Packing unpacked on pallet  
Colour M

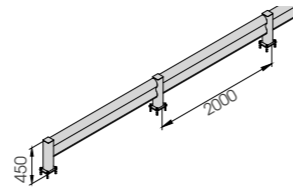

**Corners available**

Equipped with accessories



INCLUDED

S12 x 150  
GALVANISED STEEL



BFLEX.COM/2 1100x1100  
BFLEX.COM/2 2400x1100

Length 1.100 / 2.400 mm  
Packing unpacked on pallet  
Colour M

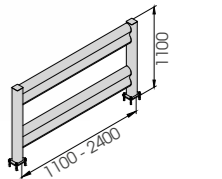

Equipped with accessories



BFLEX.COM/2 2000x1100  
MODULAR

Packing unpacked on pallet  
Colour M

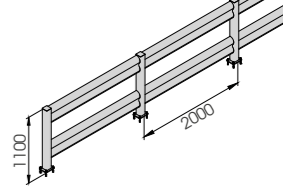

**Corners available**

Equipped with accessories



# 09

## COLUMN PROTECTION

A new bumper system specific for the protection of the columns resistant against trolleys movements and for different load types. Designed by following an innovative technical design that combines speed and simplicity in the steps of installation and cleaning. Available in different heights and fixing systems.

Sistema di profili specifico per la protezione delle colonne dai carrelli in movimento di varie portate. Progettato seguendo un innovativo disegno tecnico che coniuga rapidità e semplicità nella fasi di installazione e pulizia. Disponibile in diverse altezze e tipologie di fissaggio.

Nouveau système bumper, spécifique pour protéger les poteaux contre les mouvements des chariots. Étudié avec un modern dessin qui regroupe la rapidité et la facilité pendant l'installation et le nettoyage. Disponible en différents hauteurs et différents fixations.

Sistema de perfiles específico para la protección de las columnas de los carros en movimiento de diferentes capacidades. Diseñado según un innovador diseño técnico que une velocidad y simplicidad en las fases de instalación y limpieza. Disponible en diferentes alturas y tipos de fijación.



- REMOVABLE
- NO SCRATCHES
- VERY SOLID AND SLIM DESIGN
- NO FIXING IS REQUIRED

**NEW**

### MINI HUG TOWER

Column protection

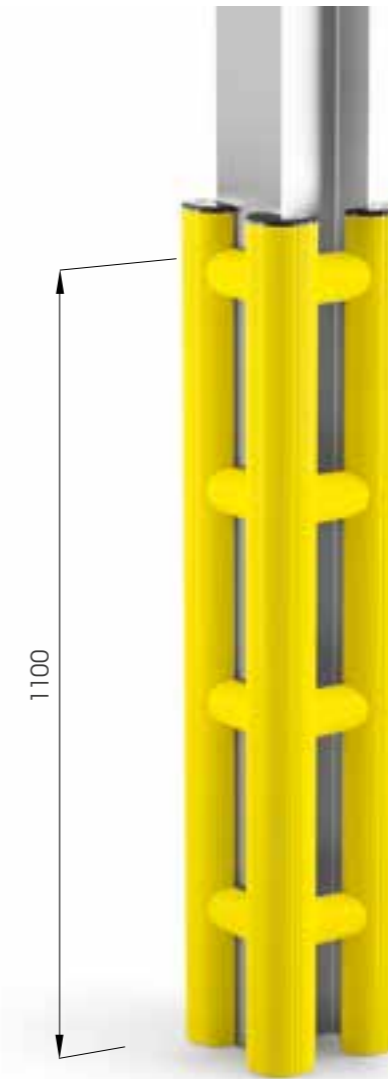

DIFFERENT SIZED AND HEIGHT ON REQUEST

COMPACT



**NO HOLES ON THE FLOOR AND COLUMN!**



**MINI HUG TOWER**

Packing Colour **to be defined**  
**M**

Equipped with accessories

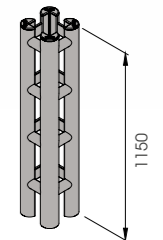

## HUG TOWER 3 SIDES



DIFFERENT SIZED ON REQUEST



WALL FIXING WITH S8FH GALVANISED STEEL

COMPACT



NO HOLES ON THE FLOOR AND COLUMN!

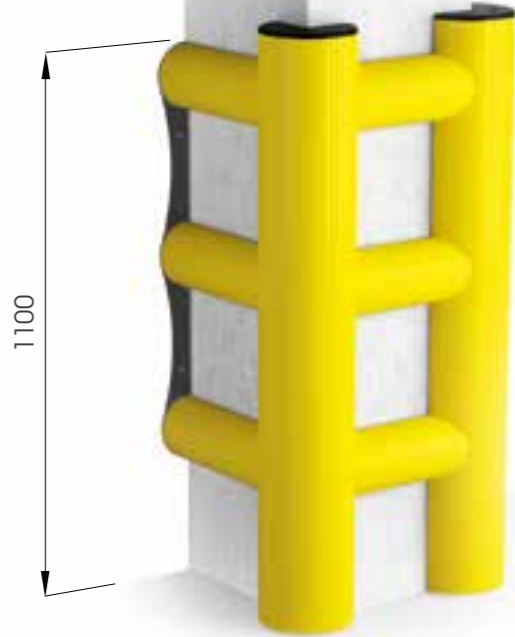

## HUG TOWER



DIFFERENT SIZED AND HEIGHT ON REQUEST

COMPACT



NO HOLES ON THE FLOOR AND COLUMN!

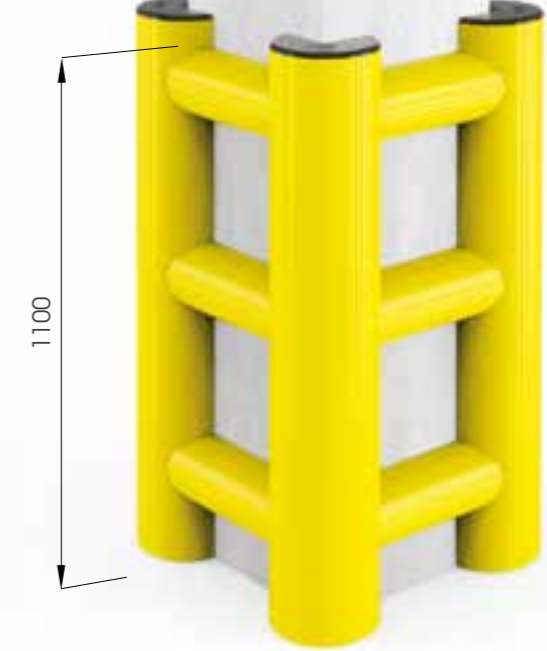
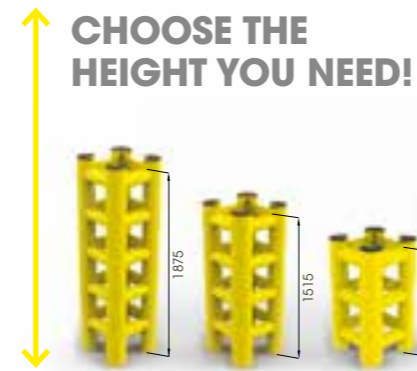

### HUG TOWER 3 SIDES

Also 2 SIDES available

Equipped with accessories

Packing Colour **M** to be defined



### HUG TOWER

Equipped with accessories

Packing Colour **M** to be defined

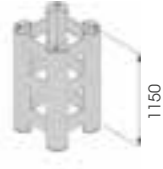

# TOWER PROTECTION



DIFFERENT SIZED AND HEIGHT ON REQUEST



M12 GALVANISED STEEL



1100

AVAILABLE ALSO:

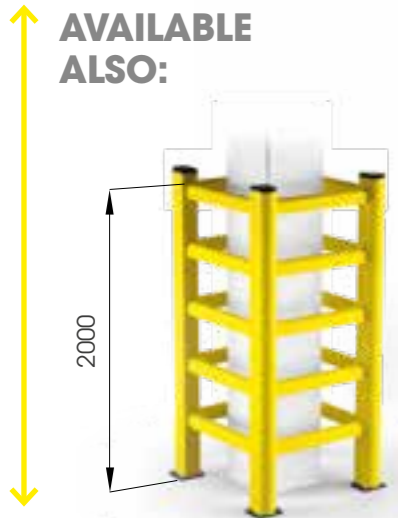

2000



## TOWER

Also 2/3 SIDES available

Equipped with accessories

Packing Colour to be defined  
 B  M



1150



# TOWER LINK



DIFFERENT SIZED AND HEIGHT ON REQUEST



M12 GALVANISED STEEL



1100

## OPTIONS



TOWER LINK/1

TOWER LINK/2

TOWER LINK/3



## TOWER LINK/1 TOWER LINK/2 TOWER LINK/3

Equipped with accessories

Packing Colour to be defined  
 B  M

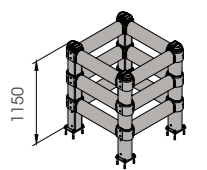

1150



# COLUMN PROTECTION 90



DIFFERENT SIZES ON REQUEST



M16 STAINLESS STEEL



COPRO 90

Also 2/3 SIDES available

Equipped with accessories

Packing Colour unpacked on pallet

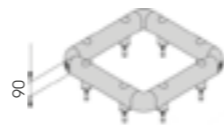

# COLUMN PROTECTION 150



DIFFERENT SIZES ON REQUEST

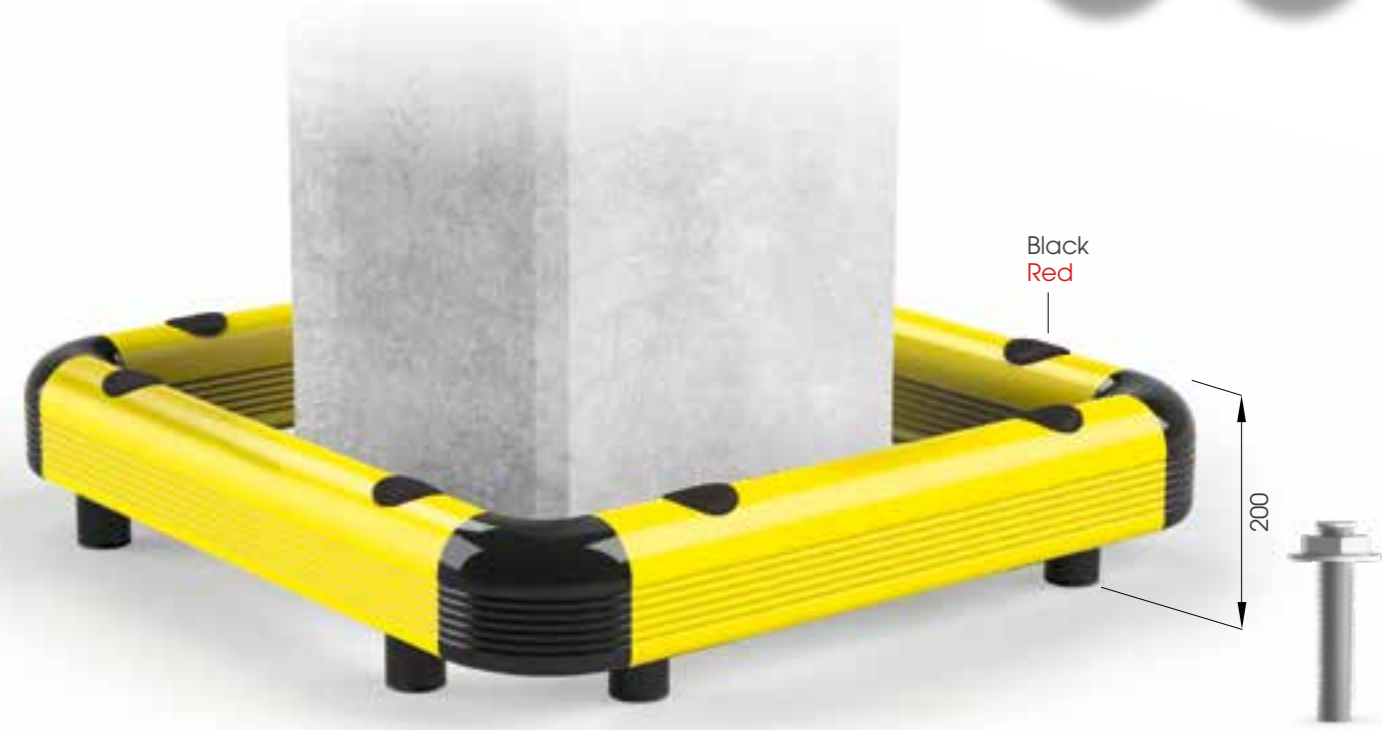

SF20 STAINLESS STEEL



COPRO 150

Also 2/3 SIDES available

Equipped with accessories

Packing Colour unpacked on pallet

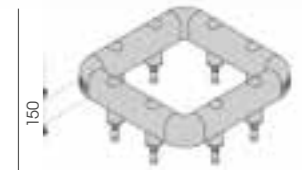

# 10

## DOOR FRAME PROTECTION

Sistema di protezione ideato per prevenire le collisioni dei carrelli elevatori in movimento con le infrastrutture sopraelevate e gli stipiti di porte e portoni. Limita il passaggio di carrelli che superano i limiti di altezza, attirando l'attenzione dei carrellisti e invitandoli ad una guida più accorta. L'installazione è consigliata in prossimità di portoni, baie di carico o di attrezzature sospese. Disponibile in diverse lunghezze.

Systèmes de protection conçus pour prévenir les collisions des chariots élévateurs en mouvement avec les infrastructures en hauteur et les montants des portes. Utiles pour empêcher le passage des chariots élévateurs qui dépassent les limites d'hauteur, pour attirer l'attention des conducteurs et de les habituer à faire plus attention à la conduite des chariots. C'est installé en proximité des bords des portes, quais de chargement et infrastructures suspendues. Disponible en plusieurs longueurs.

Sistema de protección diseñado para evitar la colisión de carretillas elevadoras en movimiento con infraestructuras, instalaciones elevadas y marcos de puertas industriales. Diseñada para limitar el paso de las carretillas que superan los límites de altura, llamando la atención de los conductores de montacargas e invitándoles a conducir con más cuidado. Se recomienda su instalación cerca de puertas industriales, muelles de carga o equipos suspendidos. Disponible en varias longitudes.

Protection system has been designed to prevent forklifts collisions with overhead infrastructure and gates and doors jambs. It is created to keep under control the passage of forklifts that exceed height limits, attracting the attention of drivers and inviting them to a more careful guide. Useful to protect gates, loading docks or overhead assets. Available in different lengths.

### WARNING BAR



**WBAR**

Equipped with accessories

Length 2000 / 3000 mm  
Packing to be defined  
Colour M

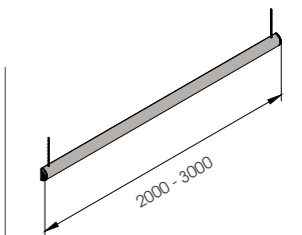

# WARNING BAR / INFORMATION SIGN



**WBIS**

Equipped with accessories

Length 2000 / 3000 mm  
Packing to be defined  
Colour M

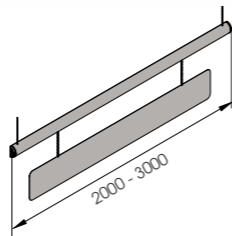

# WARNING BAR / LIGHT & SOUND



**WBLS**

Equipped with accessories

Length 2000 / 3000 mm  
Packing to be defined  
Colour M

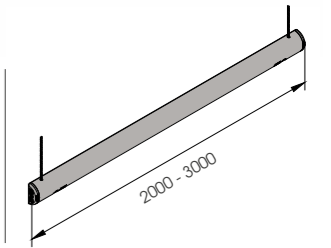

# FULL FRAME SELF STANDING



DIFFERENT SIZES ON REQUEST

FAST AND EASY TO INSTALL

NEW BIGGER PLATES!

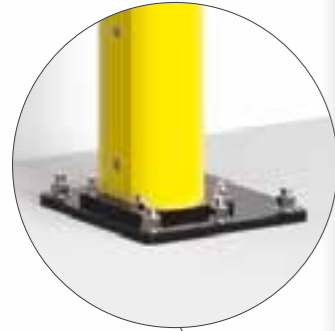

FFB SELF STANDING

Packing Colour **to be defined**  
M

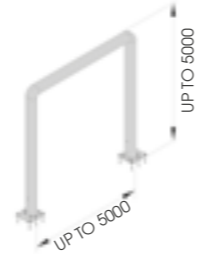

Equipped with accessories



# FULL FRAME WALL FIXING



DIFFERENT SIZES ON REQUEST

FAST AND EASY TO INSTALL

WALL FIXING ACCESSORIES



FFB WALL FIXING

Packing Colour **to be defined**  
M



Equipped with accessories





# 11 LOADING BAY PROTECTION

Loading bays protections are shock-proof solutions which are set up near loading doors. They avoid possible slipping, falling and flipping of moving vehicles near open and unmanned loading bays.

Sistema di protezione antiurto installato in prossimità delle porte di carico. Permettono di evitare situazioni ad alto rischio di scivolamento, caduta e ribaltamento dei mezzi in movimento in presenza di baie di carico aperte e non presidiate.

Système de protection contre les chocs installé près des portes de chargement. Ils permettent d'éviter des situations en raison du risque élevé de glissement, de chute et de basculement des véhicules en mouvement en présence de quais de chargement ouverts et sans surveillance.

La protección de muelles de carga es un sistema anticolidión que está cerca de las puertas de carga. Evitan los riesgos de deslizamiento, caída y derrocamiento los vehículos en movimiento cuando están cerca de los muelles de carga abiertos y no vigilados.

## DOCK GATE



M12  
GALVANISED STEEL



- DOCK GATE L 2400-2600
- DOCK GATE XL 2605-2800
- DOCK GATE XXL 2805-3000

Packing Colour  B  M to be defined

Equipped with accessories

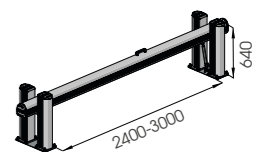

# 12

## WHEEL STOP

Solutions designed for the safety of loading and unloading zones in warehouses and parking areas. Ideal for conveying, stopping or positioning the vehicle in the parking area, or near a cargo bay.

Soluzioni progettate per la sicurezza delle zone di carico e scarico dei magazzini e dei parcheggi. Ideali per convogliare, fermare o posizionare il mezzo nell'area di parcheggio o in prossimità di una baia di carico.

Solutions conçues pour la sécurité des zones de chargement et de déchargement des entrepôts et parkings. Idéal pour transporter, arrêter ou positionner le véhicule dans l'aire de stationnement ou à proximité d'un quai de chargement.

Soluciones diseñadas para asegurar las zonas de carga y descarga de almacenes y aparcamientos. Ideal para transportar, detener o posicionar el vehículo en la zona de aparcamiento o cerca de un muelle de carga.

Wheel stop

### TRUCK LINE



DIFFERENT SIZES ON REQUEST



SF20 x 200  
STAINLESS STEEL



TL	500	2000
	750	3000
	1000	4000
	1500	

Packing Colour to be defined  
B M



Equipped with accessories



# CAR STOP

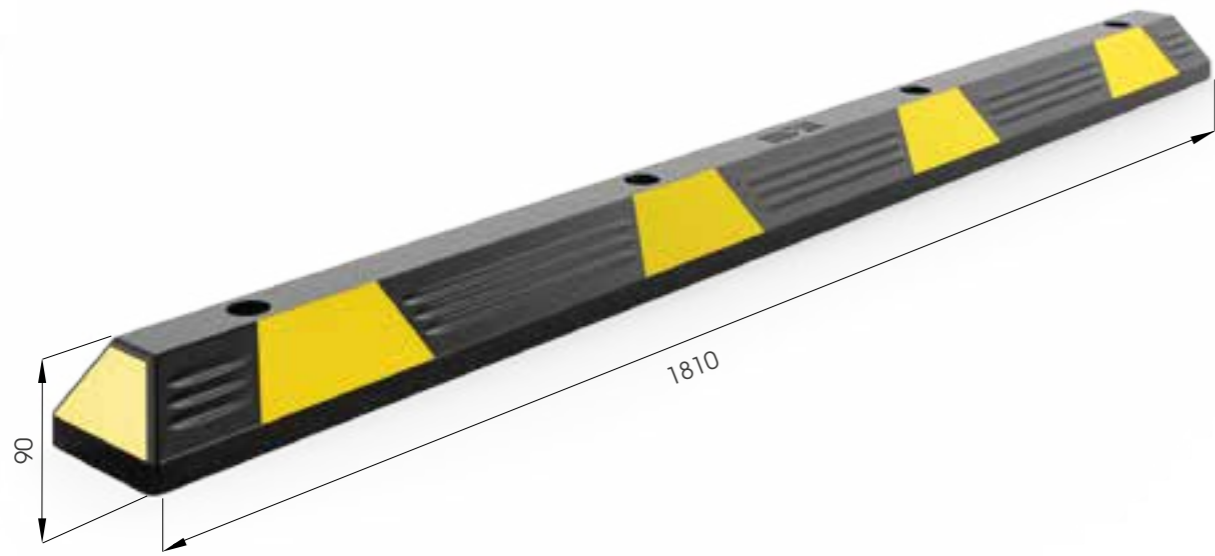

**CAR STOP**

Packing **to be defined**

Fixing on requests

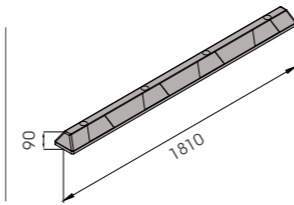

# TRUCK STOP



**TRUCK STOP**

Packing **to be defined**

Fixing on requests

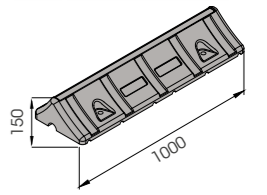

# 13

## CABLE COVER

Floor cable protection system in soft material. Space-saving, resistant and easy-to-install cable cover. Suitable for work areas with pedestrian passage.

Sistema di protezione morbido a pavimento per cavi. Passacavi poco ingombrante, resistente e facile da posare. Adatto ad aree di lavoro con passaggio di pedoni.

Système de protection de sol souple pour câbles. Guide-câble peu encombrant, résistant et facile à installer. Convient aux zones de travail avec passage piéton.

Sistema de protección blando de suelo para los cables. Pasacables que ahorra espacio, es duradero y fácil de instalar. Adecuado para zonas de trabajo con tráfico peatonal.

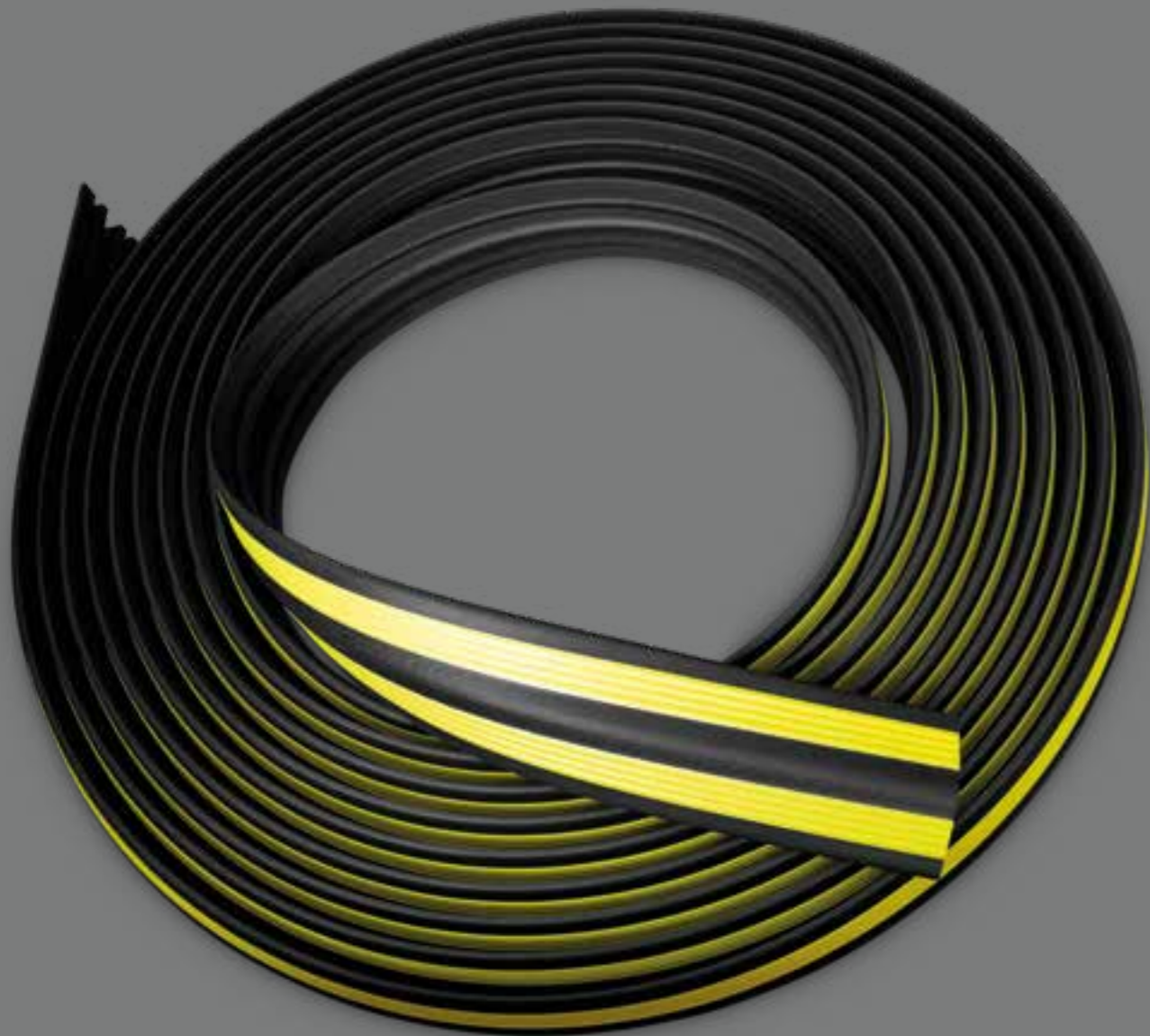

## CABLE COVER

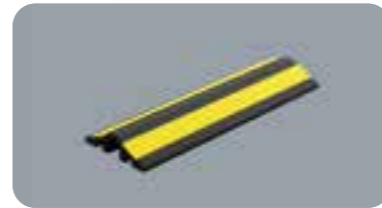

**CAB CO 10 - 20 - 10**

Length 1.000 / 3.000 mm - 10.000 mm  
Packing 8 pz / box - 1 pz / box

Recycled Material

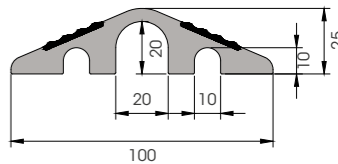

# 14

## CORNER PROTECTION

Designed to protect pillars and columns or external corners of walls and panels.

Realizzato per proteggere pilastri e colonne o angoli esterni di muri e pannelli.

Étudié pour protéger les poteaux et les colonnes ou les angles extérieurs de murs et de panneaux.

Realizado para proteger pilares y columnas o esquinas exteriores de paredes y paneles.

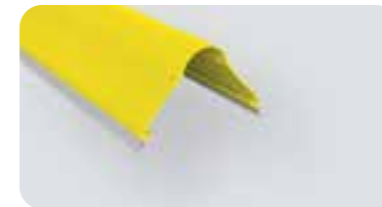

CP 100

Length 4.000 mm  
Packing 10 pz / box  
Colour B M E F

Length 2.000 mm  
Packing 10 pz / bag  
Colour M

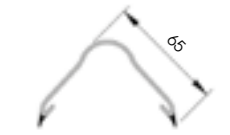

CPF 100

Length 4.000 mm  
Packing 10 pz / bag

Length 2.000 mm  
Packing 10 pz / bag



CPT 100

Packing 40 pz / box  
Colour B E F

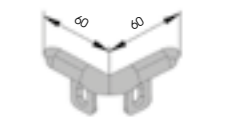

CP 200

Length 4.000 mm  
Packing 2 pz / bag  
Colour B M E

Length 2.000 mm  
Packing 2 pz / bag  
Colour M



CPF 200

Length 2.000 / 4.000 mm  
Packing 2 pz / bag



CPT 200

Packing 20 pz box  
Colour B E

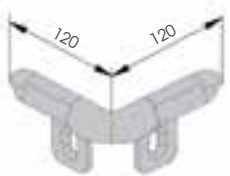

# 15

## KERB

A large size protection system, ideal for walls and panels. Easy to install and clean. Fully equipped with corner caps and buttons.

Sistema di protezione di grandi dimensioni, ideale per muri e pannelli. Facile da installare e pulire. Completo di angolari e tappi.

Système de protection de grands dimensions, idéal pour les murs et les panneaux. Facile à installer et à nettoyer. Complété de bouchons d'angles et d'embouts.

Sistema de protección de grande dimensión, ideal para paredes y paneles. Fácil de instalar y limpiar. Completo de esquinas y tapas.

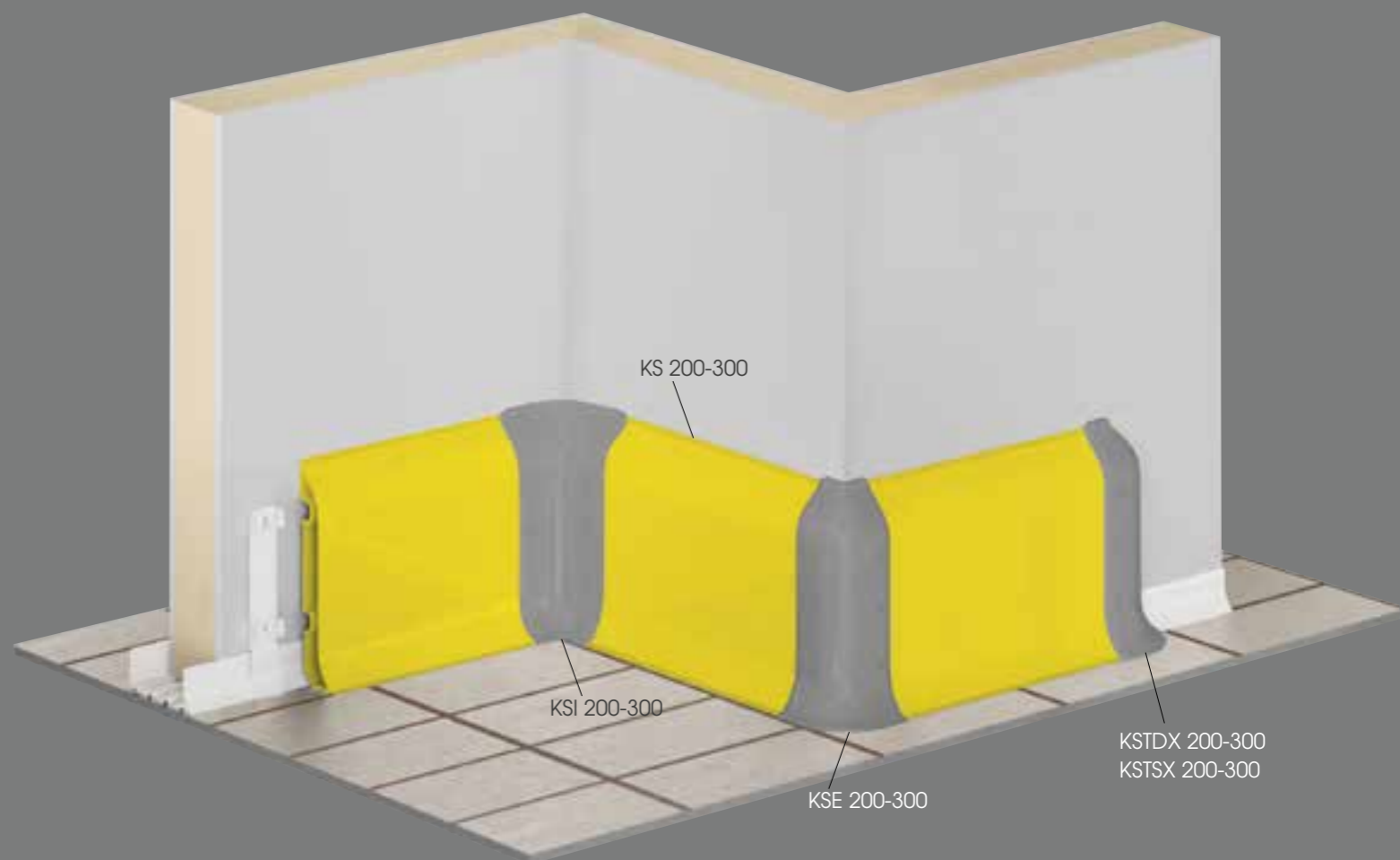



**KS 200**

Length **4.000 mm**  
 Packing **3 pz / box**  
 Colour **B M E**

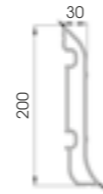

**KEPF 200**

To install with TB14

Packing **50 pz / box**  
 Colour **K**

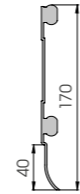

**KSJ 200**

To install with TB14 / TF14

Packing **20 pz / box**  
 Colour **B E**

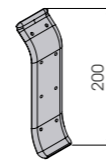

**KSI 200**

To install with TB14 / TF14

Packing **20 pz / box**  
 Colour **B E**

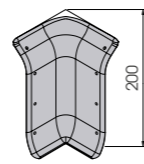

**KSE 200**

To install with TB14 / TF14

Packing **20 pz / box**  
 Colour **B E**

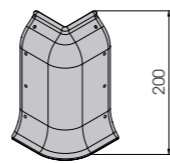

**KSTD/SX 200**

To install with TB14 / TF14

Packing **20 pz / box**  
 Colour **B E**

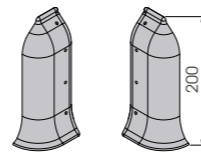

**KSJ 200 LT**

**THERMAL BREAK RESISTANT**

Packing **to be defined**  
 Colour **K**

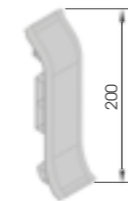

**KS 300**

Length **4.000 mm**  
 Packing **1 pz**  
 Colour **M E**



**KEPF 300**

To install with TB20

Packing **40 pz / box**

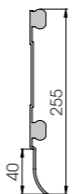

**KSJ 300**

To install with TB20 / TF20

Packing **10 pz / box**  
 Colour **B E**

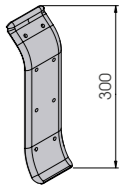

**KSI 300**

To install with TB20 / TF20

Packing **10 pz / box**  
 Colour **B E**

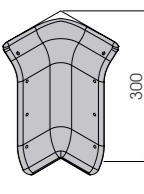

**KSE 300**

To install with TB20 / TF20

Packing **10 pz / box**  
 Colour **B E**

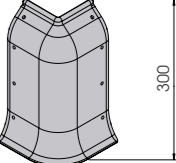

**KSTD/SX 300**

To install with TB20 / TF20

Packing **10 pz / box**  
 Colour **B E**

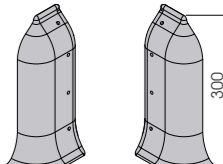

# 16

## WALL PROTECTION

New bumper without guides. Thanks to its big size and resistance it is ideal for protection of industrial spaces. Fixed caps with hidden screws covered by specific buttons.

Nuovo profilo antiurto senza guida. La sua ampiezza e resistenza lo rende ideale per la protezione di ambienti industriali. Terminali fissati con viti nascoste da appositi bottoni.

Nouveau profilé anti-choc sans besoin d'une base à fixer. Sa mesure large et sa résistance en font le profilé parfait pour la protection des espaces industriels. Embouts fixés avec des vis cachées grâce à des bouchons spécifiques.

Nuevo perfil antigolpe sin guía. Su amplitud y resistencia lo hacen ideal para la protección de entornos industriales. Terminales fijados con tornillos ocultos por botones especiales.



### Wall Protection



**WP 100**

Length **4.000 mm**  
Packing **8 pz / box**  
Colour **B E F**

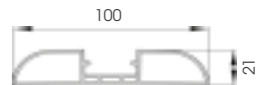

**WP 150**

Length **4.000 mm**  
Packing **4 pz / box**  
Colour **B M E**

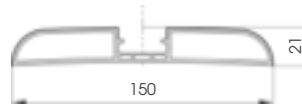

**WPC**

To install with WP 100 / WP 150

Length **4.000 mm**  
Packing **16 pz / box**  
Colour **A B M D E F G H**



**WPT 100**

To install with TM5

Packing **50 pz / box**  
Colour **B E F**

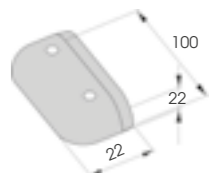

**WPA 100**

To install with TS9

Packing **20 pz / box**  
Colour **B E**

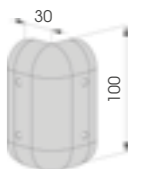

**WPT 150**

To install with TM5

Packing **50 pz / box**  
Colour **B E**

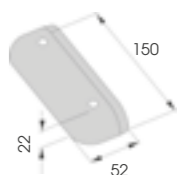

**WPA 150**

To install with TS9

Packing **20 pz / box**  
Colour **B E**

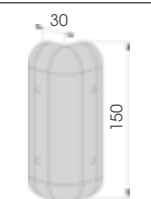



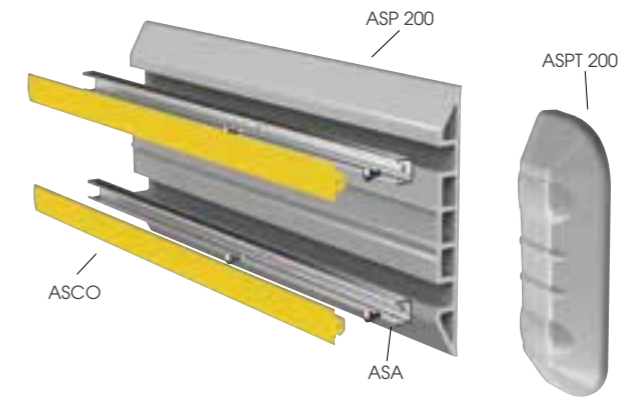
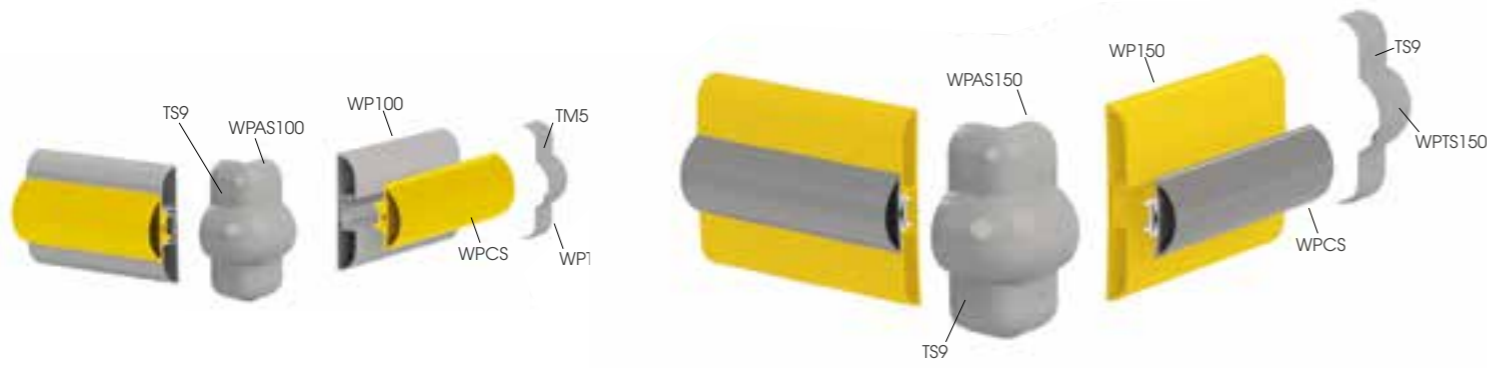

**WP 100**

Length **4.000 mm**  
Packing **8 pz / box**  
Colour **B E F**

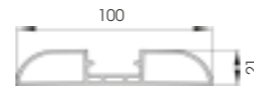

**WP 150**

Length **4.000 mm**  
Packing **4 pz / box**  
Colour **B M E**

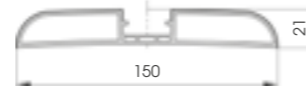

**WPCS**

To install with WP 100 / WP 150



Length **4.000 mm**  
Packing **8 pz / box**  
Colour **A B M D E F G H I**

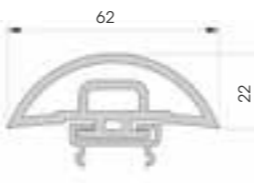

**WPTS 100**

To install with TS9

Packing **20 pz / box**  
Colour **B E**

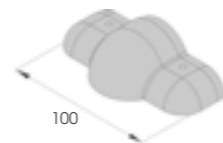

**WPAS 100**

To install with TS9

Packing **20 pz / box**  
Colour **B E**

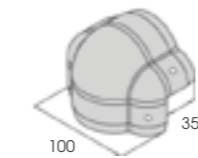

**WPTS 150**

To install with TS9

Packing **20 pz / box**  
Colour **B E**

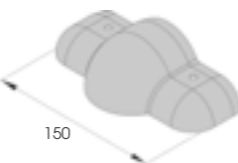

**WPAS 150**

To install with TS9

Packing **20 pz / box**  
Colour **B E**

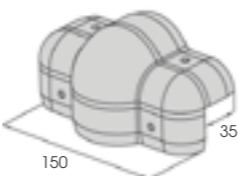

**ASP 200**



Length **4.000 mm**  
Packing **2 pz / box**  
Colour **B M**



**ASPT 200**



Packing **10 pz / box**  
Colour **B D**

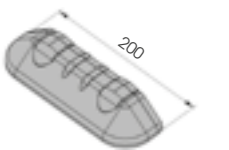

**ASA**

Material **aluminium**  
Length **4.000 mm**  
Packing **8 pz / bundle**



**ASCO**



Packing **2 pz / box**  
L = **32.000 mm**  
Colour **A B M D E**



Wall Protection



**WALL HUG** 1000  
2000  
3000  
4000

Length 1000/2000/3000/4000  
Packing unpacked  
Colour M



**WALL BFLEX** 1000  
2000  
3000  
4000

Length 1000/2000/3000/4000  
Packing unpacked  
Colour M

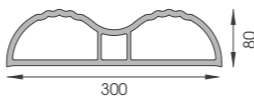

**WALL BFLEX MODULAR**

Packing unpacked  
Colour M

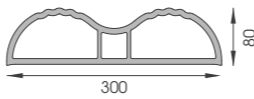

# NEWS



**LOFT BARRIER**  
WORLD'S FIRST FIXED PROTECTION  
SYSTEM FOR SUSPENDED AREAS

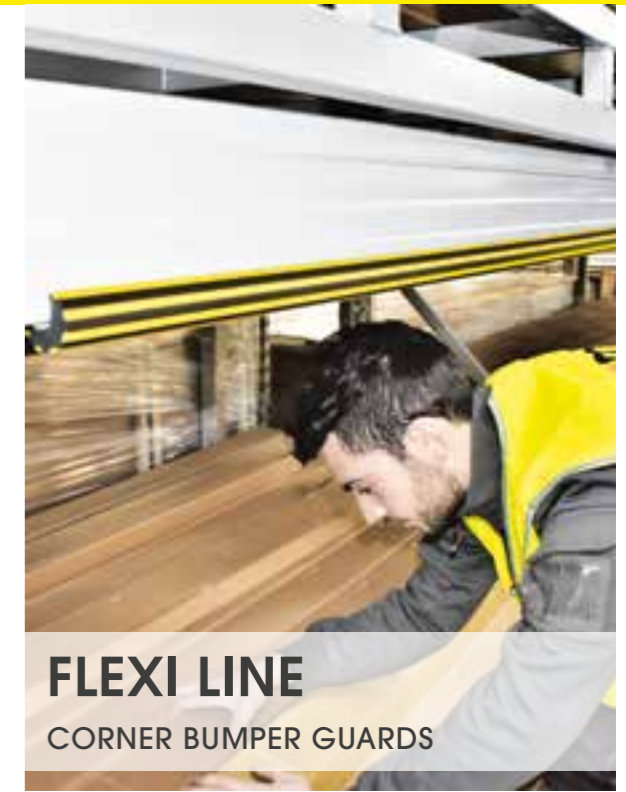

**FLEXI LINE**  
CORNER BUMPER GUARDS



**FENCE LINK**  
THE ADAPTABLE STRONGEST  
SOLUTION FOR RACK-ENDS

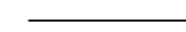

Now available  
**CUSTOMISED RACK PROTECTOR,**  
new version of rack protector  
processed upon request!

**CUSTOMISED RACK PROTECTOR**



**M12 - M16**  
HILTI  
Hole required Ø 12-16  
Galvanized steel.



**S12 - S12X150 - S16**  
HILTI  
Hole required Ø 10-10-14  
Galvanized steel.



**B12 - B16 - B20**  
HILTI  
Hole required Ø 22-28-32  
Galvanized steel.



**S8FH - S12FH**  
HILTI  
Hole required Ø 6-10  
Galvanized steel.  
Countersunk.



**SF12 - SF16 - SF20 INOX**  
Hole required Ø 14-18-24  
Stainless steel.



**M12 - M16 INOX**  
Hole required Ø 12-16  
Stainless steel.



**KIT ROD 70-120**  
HILTI  
Hole required Ø 38-56  
Galvanized steel.



**KIT ROD 70-120 INOX**  
HILTI  
Hole required Ø 38-56  
Galvanized steel.



**AA12 - AA16**  
Hole required Ø 22-22  
Galvanized steel.  
For asphalt.



**ASPHALT CHEMICAL**  
CHEMICAL ANCHOR  
385 ML



**FR**  
HILTI CHEMICAL ANCHOR  
300 ML



**WIT NORDIC**  
CHEMICAL ANCHOR  
420 ML  
(Installation in working cold rooms  
with negative temperatures)



MPM srl reserves the right, at any time, to introduce the necessary changes and improvements to its products. Any small imperfection in the products and in the materials used are due to the processing method. Any reproduction of this brochure, even in part, is forbidden.



**TM5**  
Hole required Ø 8.5  
Neutral polyethylene. 100/500 Pcs. / bag.



**TS9**  
Hole required Ø 5  
White or grey nylon. 1000 Pcs. / bag.



**TB14 - TB20**  
Hole required Ø 4-5  
Steel / aluminium (white for Ø 4)  
500 Pcs. / box.



**TF14 - TF20**  
Hole required Ø 5-6.5  
Aluminium. 500 Pcs. / box.



**FIX P90**  
Galvanized steel and painted.



**COVER 90 RE**  
Galvanized steel and painted.



**FIX P90 INOX**  
Stainless steel.



**FIX P150**  
Galvanized steel and painted.



**COVER 150 RE**  
Galvanized steel and painted.



**FIX P150 INOX**  
Stainless steel.



**FIX P150 FH**  
Galvanized steel and painted.  
Countersunk.



**FULL FRAME BASE**  
Galvanized steel and painted.



**SHOCK ABSORBER PAD**  
Soft material, optional for FIXP150.  
(To be installed with S12x150)

Colours

<b>A</b>	<b>B</b>	<b>D</b>	<b>E</b>	<b>F</b>	<b>G</b>	<b>H</b>	<b>I</b>	<b>K</b>	<b>L</b>	<b>M</b>	<b>P</b>
RED RAL 3002	GREY RAL 7040	BLACK RAL 9005	WHITE RAL 9010	WHITE RAL 9002	BLUE RAL 5005	GREEN RAL 6029	SILVER RAL 9006	LIGHT GREY RAL 7035	DARK GREY RAL 7024	LIGHT YELLOW RAL 1018	ORANGE

MPM srl reserves the right, at any time, to introduce the necessary changes and improvements to its products. Any small imperfection in the products and in the materials used are due to the processing method. Any reproduction of this brochure, even in part, is forbidden.



SOME OF OUR REFERENCES



THE WORLD'S TOP **LOGISTICS**  
PROFESSIONALS CHOOSE OUR  
**QUALITY MADE IN ITALY**



# OUR INSTALLATION



# OUR INSTALLATION



# OUR INSTALLATION



## MPM states that:

The safety coefficient and consequent use of the products requires the compliance with the appropriate assembling and installation instructions as defined in the technical catalogue on the corporate website [www.mpmprotections.com](http://www.mpmprotections.com). Therefore, before buying and installing MPM solutions please consult the technical data sheet of each product in the technical catalogue available on [www.mpmprotections.com](http://www.mpmprotections.com)

Impact resistances indicated in the brochure, or in other documents, refer to laboratory tests and cannot take into account consequences determined by installation methods or peculiarities of the place where the products are installed (in an operational environment vehicle type, speed and mass, routes, angles of impact, ground and anchorage are variable and uncontrolled conditions that no test can replicate); the data refers to an intact product which length is indicated on the test report and it can be affected by alterations from incorrect maintenance, wear and tear, as well as the methods and characteristics of installation (with specific reference to floor-mounted products); the weight, dimensions, colours and characteristics of the material refer to the sample and the conformity with the latter of the product supplied will be subject to normal production tolerance. The product may be affected by environmental installation conditions.

The standard operating temperature of MPM flexible protections is generally from +5 °C to +60 °C. For installations in low temperature environments up to -30 °C an alternative material should be required. The fastness of the colour and its brightness depend on wear and tear and weather conditions that can affect its intensity over time. For outdoor applications exposed to direct sunlight it is possible to choose the grey colour.

Images in the brochure are for advertising purposes only and do not in any way represent how the products should be used.

Full version of MPM products warranty available on corporate website [www.mpmprotections.com](http://www.mpmprotections.com)





MADE IN  
ITALY



ALWAYS  
DYNAMIC



**M.P.M. s.r.l.**  
Via Europa 2  
35010 Fratte  
di S. Giustina in Colle  
Padova · Italy

T +39 049 9301773  
F +39 049 9300427  
info@mpmpvc.com  
mpmprotections.com

**NOVEMBER 2021**